



SMN02U028DSH

N-Channel Enhancement Mode Field Effect Transistor

FEATURES

· Suffix "H" indicates Halogen-free parts, ex. SMN02U028DSH

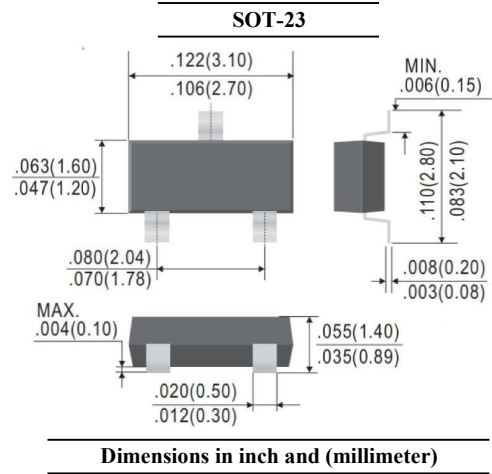
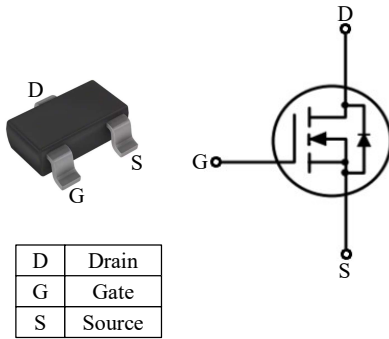

Maximum Ratings ($T_A=25\text{ }^\circ\text{C}$ unless otherwise noted)

Parameter	Symbol	Value	Unit
Drain-Source Voltage	V_{DSS}	20	V
Gate-Source Voltage	V_{GSS}	± 12	V
Drain Current	I_D	4.2	A
Pulsed Drain Current (Note 1)	I_{DM}	24	A
Power Dissipation (Note 2)	P_D	1	W
Thermal Resistance from Junction to Ambient (Note 2)	$R_{\theta JA}$	125	$^\circ\text{C}/\text{W}$
Operating and Storage Temperature Range	T_J, T_{stg}	- 55 to + 150	$^\circ\text{C}$

Note :

1. Pulse Test: Pulse Width $\leq 100\mu\text{s}$, Duty Cycle $\leq 2\%$, Repetitive rating, pulse width limited by junction temperature $T_{J(MAX)}=150^\circ\text{C}$.
2. Device mounted on FR-4 substrate PC board, 2oz copper, with 1-inch square copper plate in still air.



SMN02U028DSH

N-Channel Enhancement Mode Field Effect Transistor

Electrical Characteristics ($T_A = 25\text{ }^\circ\text{C}$ unless otherwise specified)

Parameter	Conditions	Symbol	Min.	Typ.	Max.	Unit
Static						
Drain Source Breakdown Voltage	$I_D = 250\mu\text{A}$	V_{DSS}	20	-	-	V
Gate Threshold Voltage	$V_{DS} = V_{GS}, I_D = 250\mu\text{A}$	$V_{GS(th)}$	0.4	-	1.2	V
Zero Gate Voltage Drain Current	$V_{DS} = 20\text{V}$	I_{DSS}	-	-	1	μA
Gate-Body Leakage Current	$V_{GS} = \pm 12\text{V}$	I_{GSS}	-	-	± 0.1	μA
Drain-Source On-State Resistance	$V_{GS} = 4.5\text{V}, I_D = 4.2\text{A}$	$R_{DS(on)}$	-	28	40	m Ω
	$V_{GS} = 2.5\text{V}, I_D = 3\text{A}$		-	-	50	
Gate Resistance	$V_{DS} = 0\text{V}, V_{GS} = 0\text{V}, f = 1\text{MHz}$	R_g	-	2.5	-	Ω
Dynamic						
Total Gate Charge	$V_{DS} = 10\text{V}, I_D = 1\text{A}, V_{GS} = 4.5\text{V}$	Q_g	-	7.6	-	nC
Gate-Source Charge		Q_{gs}	-	1.3	-	
Gate-Drain Charge		Q_{gd}	-	2.0	-	
Input Capacitance	$V_{DS} = 10\text{V}, V_{GS} = 0\text{V}, f = 1\text{MHz}$	C_{iss}	-	481	-	pF
Output Capacitance		C_{oss}	-	85	-	
Reverse Transfer Capacitance		C_{rss}	-	63	-	
Turn-On Delay Time	$V_{GS} = 4.5\text{V}, V_{DD} = 10\text{V}, I_D = 1\text{A}, R_g = 4.7\Omega$	$t_{d(on)}$	-	11.3	-	ns
Turn-On Rise Time		t_r	-	5.4	-	
Turn-Off Delay Time		$t_{d(off)}$	-	14.0	-	
Turn-Off Fall Time		t_f	-	2.9	-	
Drain-Source Body Diode						
Drain-Source Diode Forward Voltage	$V_{GS} = 0\text{V}, I_S = 1\text{A}$	V_{SD}	-	-	1.2	V
Diode Continuous Source Current	-	I_S	-	-	4.2	A
Reverse Recovery Time	$I_S = 1\text{A}, di/dt = 100\text{A}/\mu\text{s}$	t_{rr}	-	7.4	-	ns
Reverse Recovery Charge		Q_{rr}	-	2	-	nC



SMN02U028DSH

N-Channel Enhancement Mode Field Effect Transistor

RATINGS AND CHARACTERISTIC CURVES

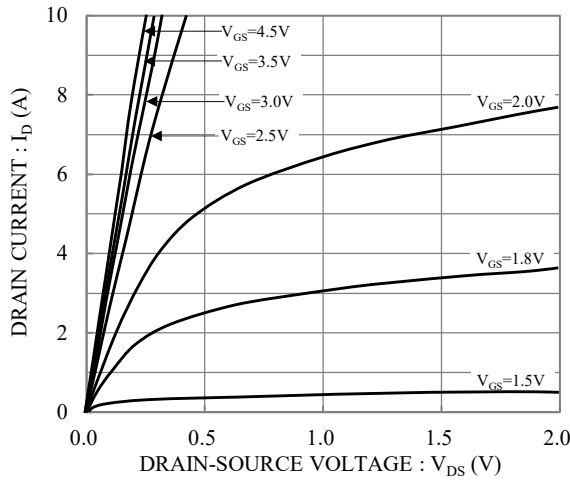

Fig.1 Typical Output Characteristics

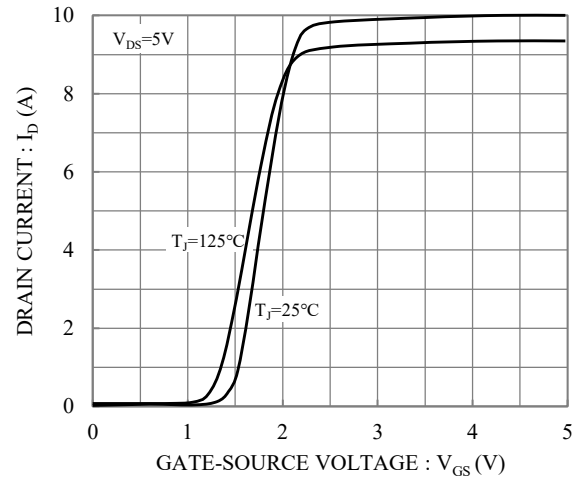

Fig.2 Typical Transfer Characteristics

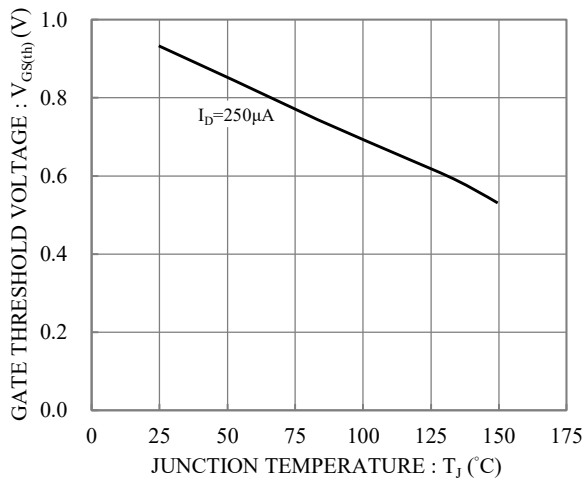

Fig.3 Gate Threshold Voltage vs. Junction Temperature

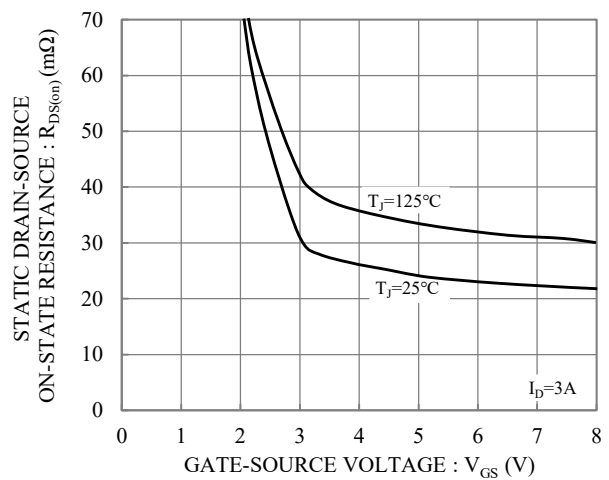

Fig.4 Static Drain-Source On-State Resistance vs. Gate-Source Voltage

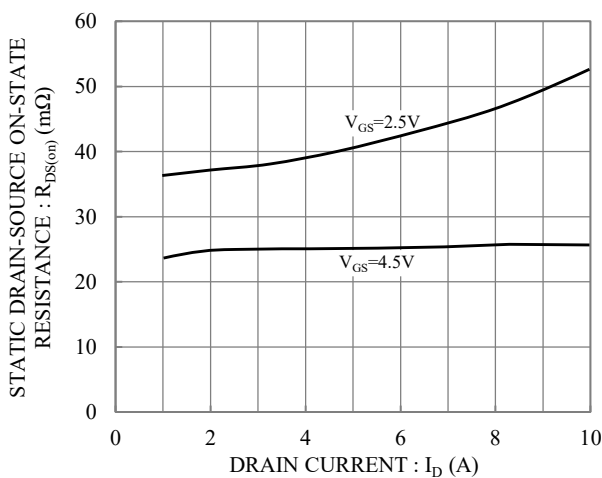

Fig.5 Static Drain-Source On-State Resistance vs. Drain Current

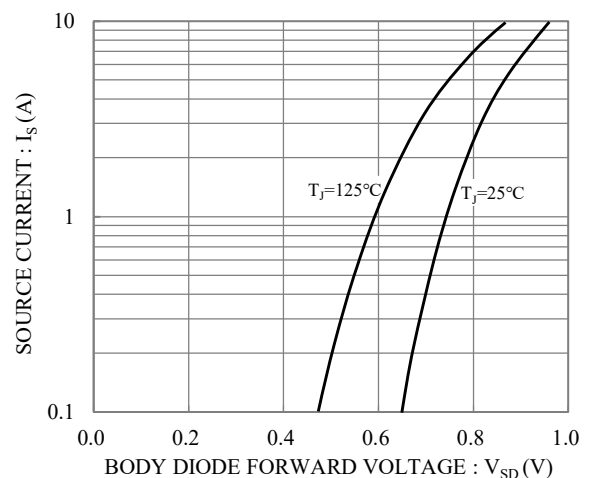

Fig.6 Body Diode Forward Voltage vs. Source Current



SMN02U028DSH

N-Channel Enhancement Mode Field Effect Transistor

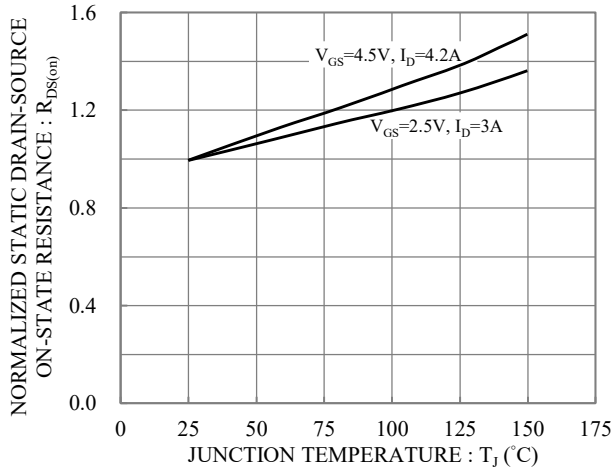

Fig.7 Drain-Source On-State Resistance vs Junction Temperature

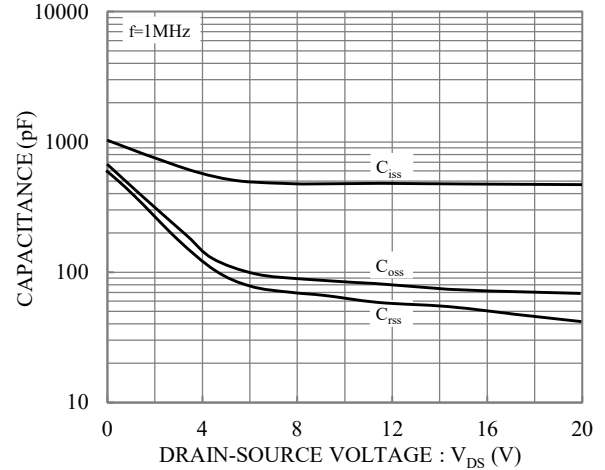

Fig.8 Capacitance vs Drain-Source Voltage

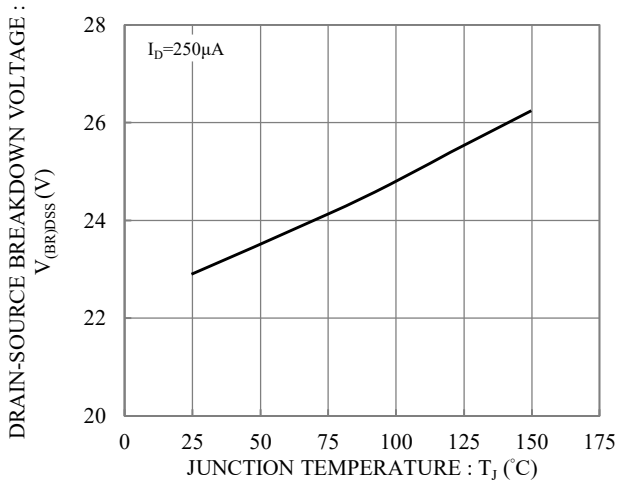

Fig.9 Breakdown Voltage vs Junction Temperature

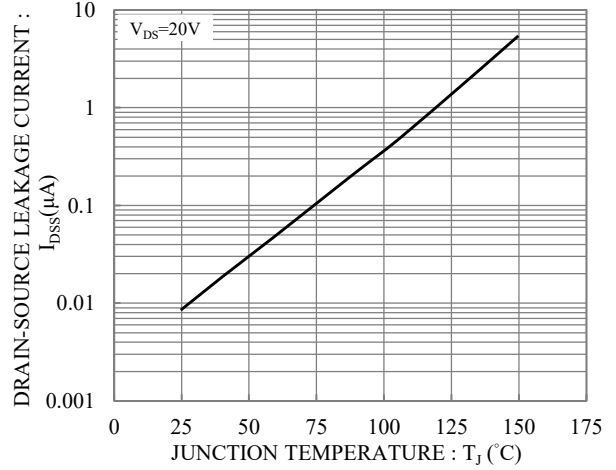

Fig.10 Drain-Source Leakage Current vs Junction Temperature

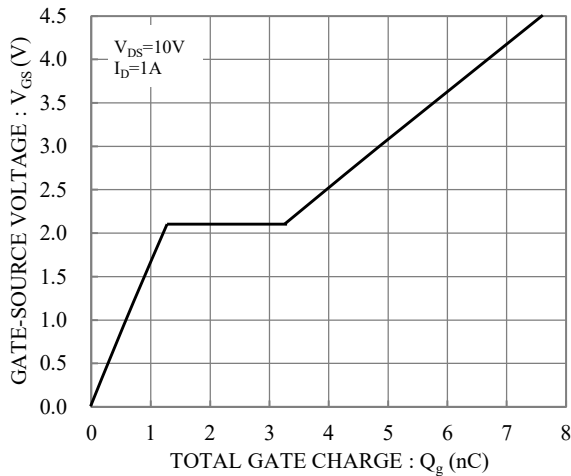

Fig.12 Gate Charge



SMN02U028DSH

N-Channel Enhancement Mode Field Effect Transistor

TAPE & REEL SPECIFICATION

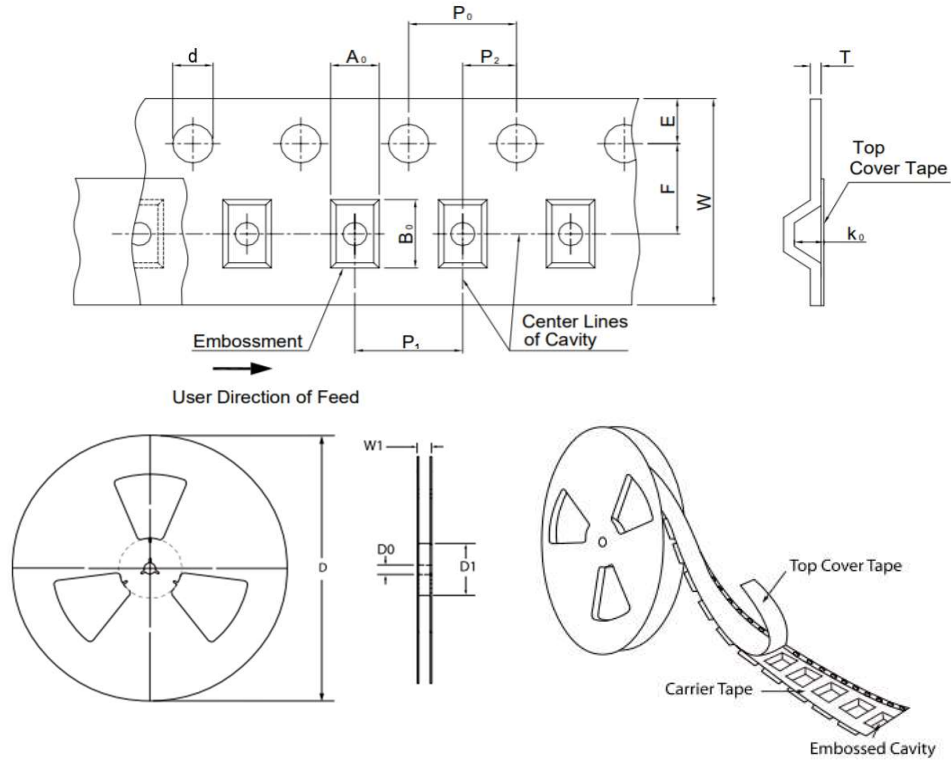

Item	Symbol	SOT-23
Carrier width	A ₀	3.30 ± 0.10
Carrier length	B ₀	3.00 ± 0.10
Carrier depth	K ₀	1.70 ± 0.10
Sprocket hole	d	1.50 ± 0.10
Reel outside diameter	D	178.00 ± 2.00
Feed hole width	D ₀	13.00 ± 0.50
Reel inner diameter	D ₁	MIN. 50.00
Sprocket hole position	E	1.75 ± 0.10
Punch hole position	F	3.50 ± 0.10
Sprocket hole pitch	P ₀	4.00 ± 0.10
Punch hole pitch	P ₁	4.00 ± 0.10
Embossment center	P ₂	2.00 ± 0.10
Overall tape thickness	T	0.20 ± 0.05
Tape width	W	8.00 ± 0.20
Reel width	W1	MAX. 14.50

ORDER INFORMATION

Package	Reel Size	Quantity
SOT-23	7"	3,000

MARKING CODE

Part Number	Marking Code
SMN02U028DSH	M25



SMN02U028DSH

N-Channel Enhancement Mode Field Effect Transistor

SUGGESTED SOLDER PAD LAYOUT

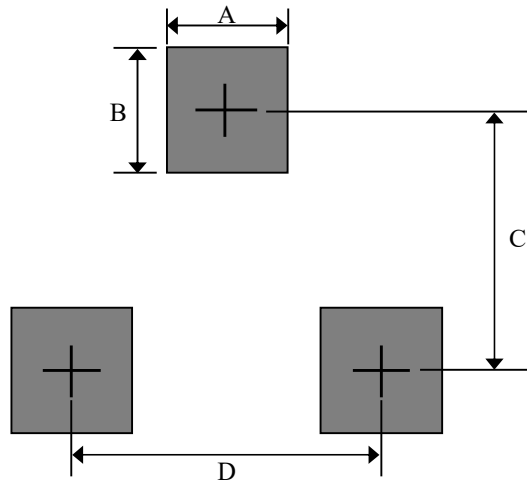

Unit : mm

PACKAGE	A	B	C	D
SOT-23	0.80	1.00	2.40	1.90