



# SM2302TDSH

## N-Channel Enhancement Mode Field Effect Transistor

### FEATURES

· Suffix "H" indicates Halogen-free parts, ex. SM2302TDSH

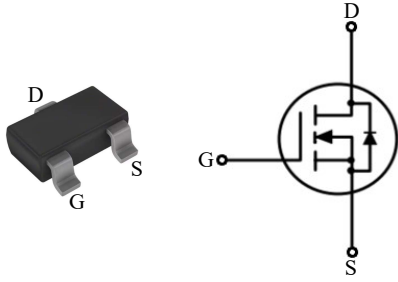

D	Drain
G	Gate
S	Source

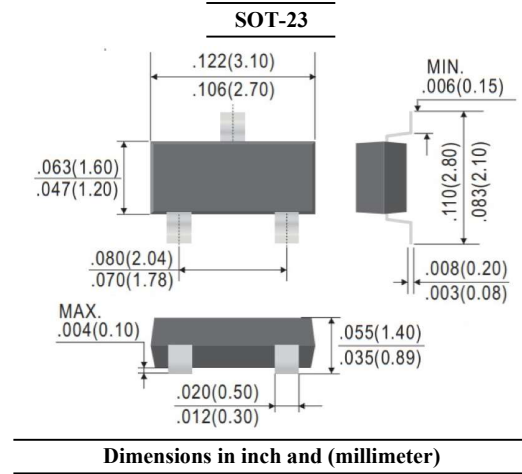

### Maximum Ratings ( $T_A = 25\text{ }^\circ\text{C}$ unless otherwise noted)

Parameter	Symbol	Value	Unit	
Drain-Source Voltage	$V_{DS}$	20	V	
Gate-Source Voltage	$V_{GS}$	$\pm 8$	V	
Drain Current	$I_D$	2.9	A	
Pulsed Drain Current (Note 1)	$I_{DM}$	10	A	
Power Dissipation (Note 2)	Steady state $t \leq 10s$	$P_{tot}$	0.71	W
			1.40	
Thermal Resistance from Junction to Ambient (Note 2)	Steady state $t \leq 10s$	$R_{\theta JA}$	176	$^\circ\text{C/W}$
			89	
Operating and Storage Temperature Range	$T_J, T_{stg}$	- 55 to + 150	$^\circ\text{C}$	

Note :

1. Pulse test: Pulse width  $\leq 100\mu s$ , Duty cycle  $\leq 2\%$ , Repetitive rating, pulse width limited by junction temperature  $T_{J(MAX)} = 150^\circ\text{C}$ .
2. Device mounted on FR-4 substrate PC board, 2oz copper, with 1-inch square copper plate in still air.



# SM2302TDSH

## N-Channel Enhancement Mode Field Effect Transistor

### Electrical Characteristics ( $T_A = 25^\circ\text{C}$ unless otherwise specified)

Parameter	Conditions	Symbol	Min.	Typ.	Max.	Unit
<b>Static</b>						
Drain Source Breakdown Voltage	$I_D = 250\mu\text{A}$	$V_{DSS}$	20	-	-	V
Gate Threshold Voltage	$V_{GS} = V_{DS}, I_D = 250\mu\text{A}$	$V_{GS(th)}$	0.40	-	0.85	V
Zero Gate Voltage Drain Current	$V_{DS} = 20\text{V}$	$I_{DSS}$	-	-	1	$\mu\text{A}$
Gate-Body Leakage Current	$V_{GS} = \pm 8\text{V}$	$I_{GSS}$	-	-	$\pm 0.1$	$\mu\text{A}$
Drain-Source On-State Resistance	$V_{GS} = 4.5\text{V}, I_D = 3.6\text{A}$	$R_{DS(on)}$	-	-	57	m $\Omega$
	$V_{GS} = 2.5\text{V}, I_D = 3.1\text{A}$		-	-	75	
Forward Transconductance	$V_{DS} = 5\text{V}, I_D = 3.6\text{A}$	$g_{FS}$	-	9	-	S
<b>Dynamic</b>						
Gate Resistance	$V_{DS} = 0, f = 1\text{MHz}$	$R_g$	-	0.6	-	$\Omega$
Total Gate Charge	$V_{GS} = 4.5\text{V}, V_{DS} = 10\text{V}, I_D = 3.6\text{A}$	$Q_g$	-	8.7	-	nC
Gate-Source Charge		$Q_{gs}$	-	1.6	-	
Gate-Drain Charge		$Q_{gd}$	-	3.3	-	
Input Capacitance	$V_{DS} = 15\text{V}, V_{GS} = 0\text{V}, f = 1\text{MHz}$	$C_{iss}$	-	610	-	pF
Output Capacitance		$C_{oss}$	-	95	-	
Reverse Transfer Capacitance		$C_{rss}$	-	72	-	
Turn-On Delay Time	$V_{DD} = 10\text{V}, I_D = 1\text{A}, V_{GS} = 4.5\text{V}, R_G = 2.2\Omega$	$t_{d(on)}$	-	12.0	-	ns
Turn-On Rise Time		$t_r$	-	30.0	-	
Turn-Off Delay Time		$t_{d(off)}$	-	13.0	-	
Turn-Off Fall Time		$t_f$	-	2.3	-	
<b>Drain-Source Body Diode</b>						
Drain-Source Diode Forward Voltage	$I_S = 0.95\text{A}$	$V_{SD}$	-	-	1.2	V
Reverse Recovery Time	$I_S = 3.6\text{A}, di/dt = 100\text{A}/\mu\text{s}$	$t_{rr}$	-	12	-	ns
Reverse Recovery Charge		$Q_{rr}$	-	2.2	-	nC



# SM2302TDSH

## N-Channel Enhancement Mode Field Effect Transistor

### RATINGS AND CHARACTERISTIC CURVES

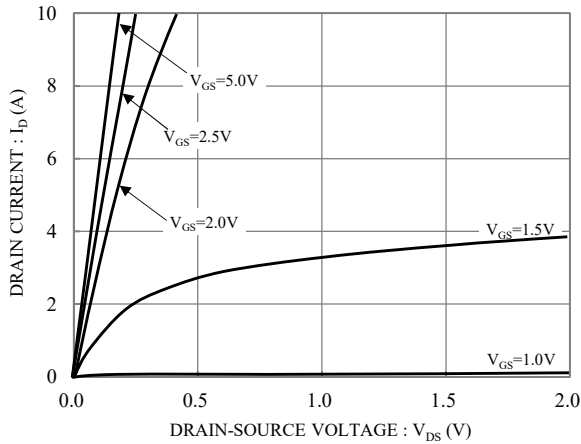

**Fig.1 Typical Output Characteristics**

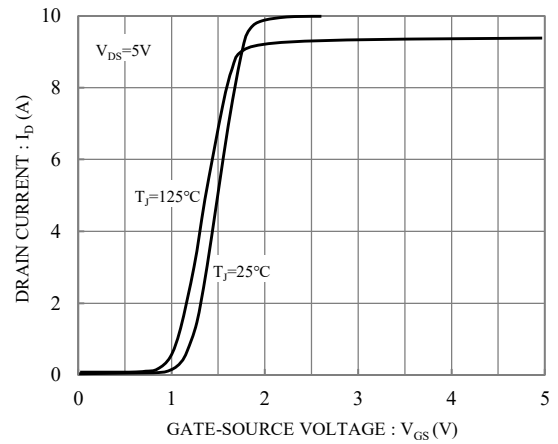

**Fig.2 Typical Transfer Characteristics**

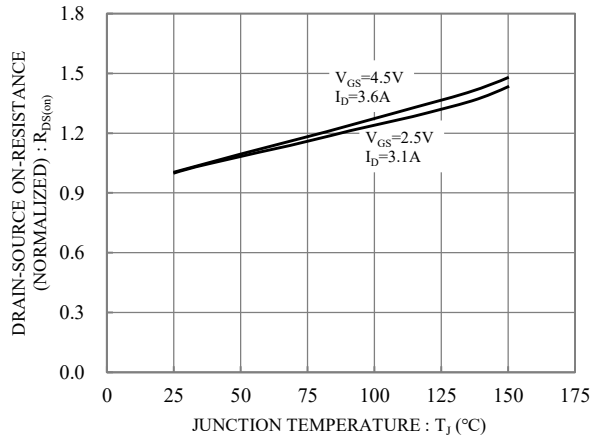

**Fig.3 On-Resistance vs Junction Temperature**

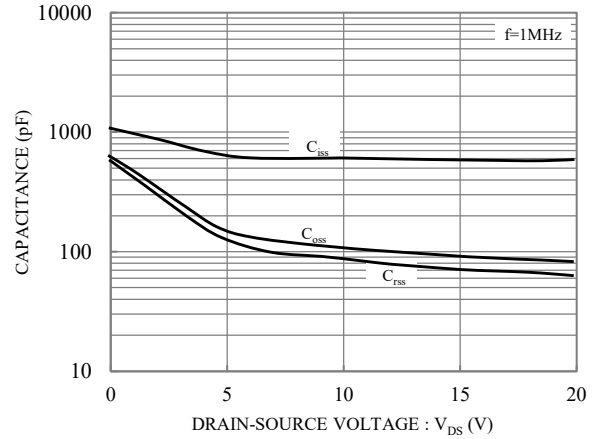

**Fig.4 Capacitance vs Drain-Source Voltage**

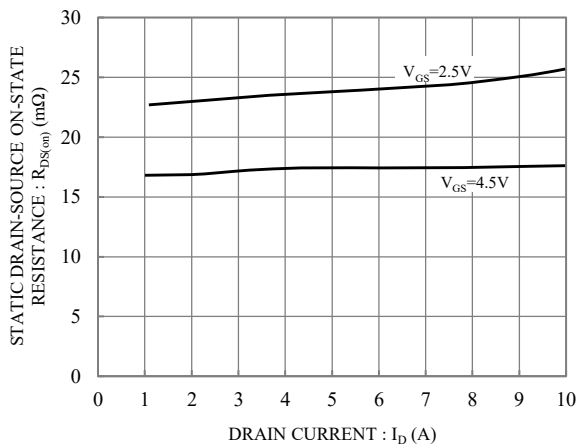

**Fig.5 Static Drain-Source On-State Resistance vs. Drain current**

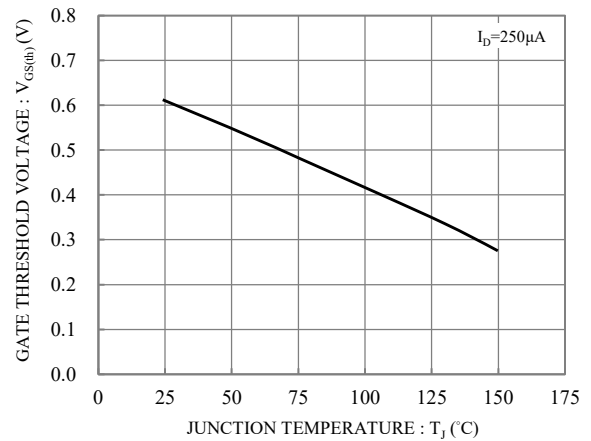
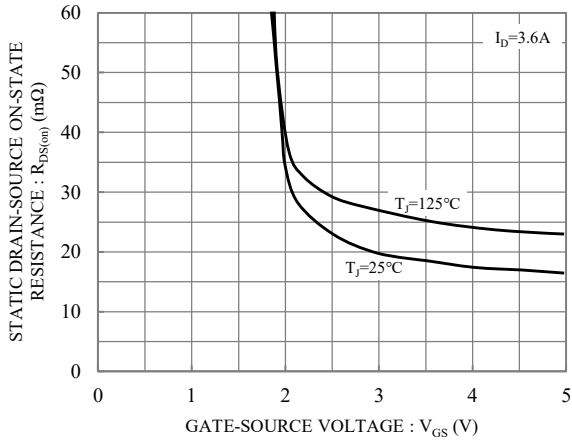

**Fig.6 Gate Threshold Voltage vs. Junction Temperature**



# SM2302TDSH

## N-Channel Enhancement Mode Field Effect Transistor



**Fig.7 Static Drain-Source On-State Resistance vs Gate-Source Voltage**

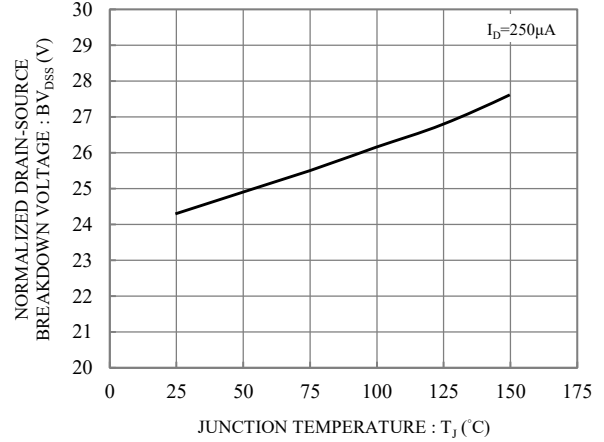

**Fig.8 Breakdown Voltage vs Junction Temperature**

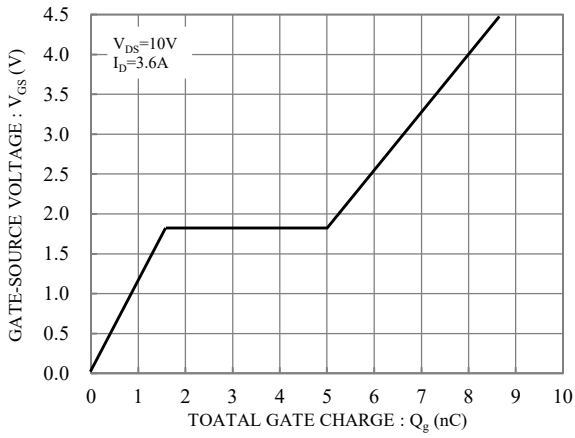

**Fig.9 Gate Charge**

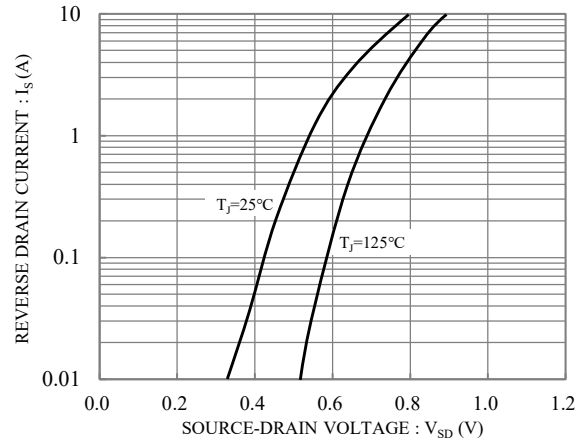

**Fig.10 Typical Forward Characteristic**

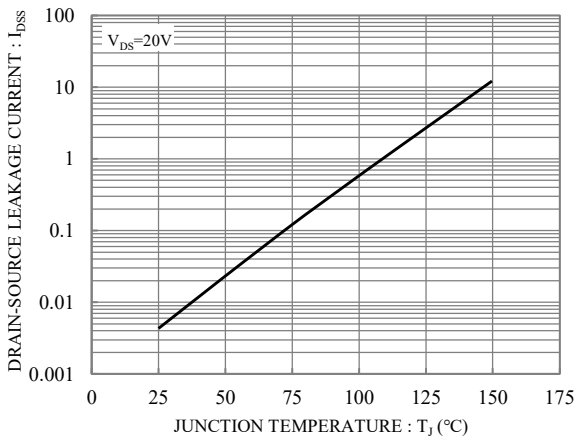

**Fig.11 Drain-Source Leakage Current vs Junction Temperature**

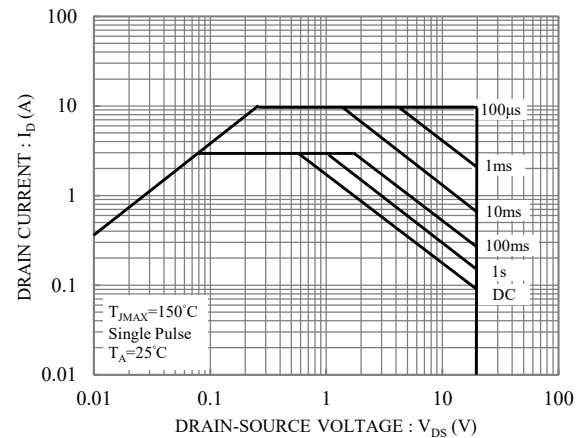

**Fig.12 Safe Operation Area**



# SM2302TDSH

## N-Channel Enhancement Mode Field Effect Transistor

### TAPE & REEL SPECIFICATION

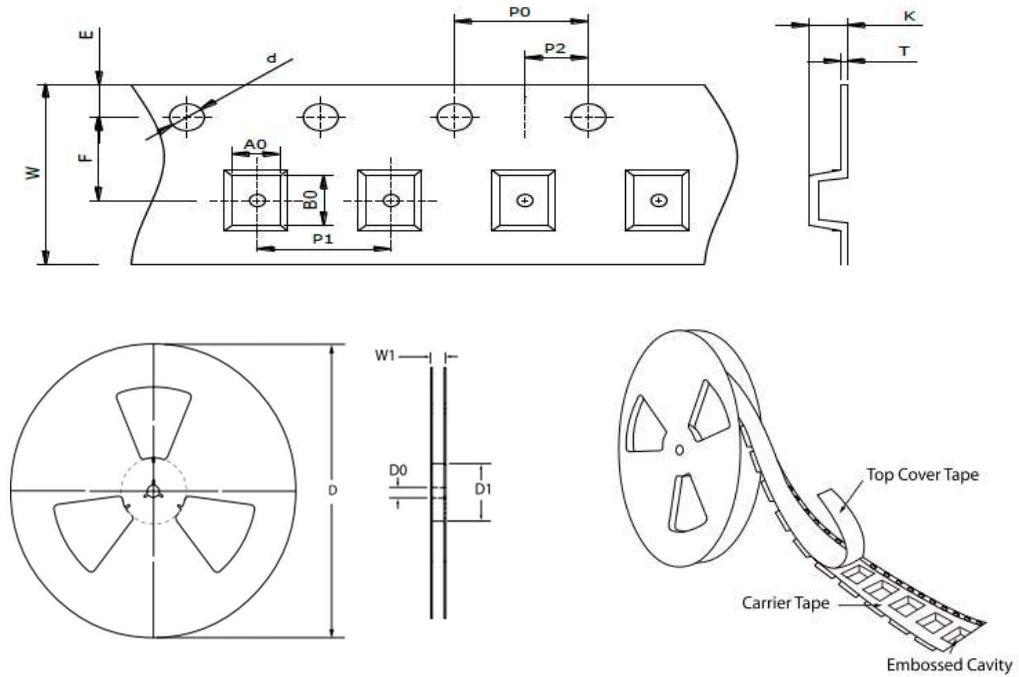

Item	Symbol	SOT-23
Carrier width	A <sub>0</sub>	3.30 ± 0.10
Carrier length	B <sub>0</sub>	3.00 ± 0.10
Carrier depth	K	1.70 ± 0.10
Sprocket hole	d	1.50 ± 0.10
Reel outside diameter	D	178.00 ± 2.00
Feed hole width	D <sub>0</sub>	13.00 ± 0.50
Reel inner diameter	D <sub>1</sub>	MIN. 50.00
Sprocket hole position	E	1.75 ± 0.10
Punch hole position	F	3.50 ± 0.10
Sprocket hole pitch	P <sub>0</sub>	4.00 ± 0.10
Punch hole pitch	P <sub>1</sub>	4.00 ± 0.10
Embossment center	P <sub>2</sub>	2.00 ± 0.10
Overall tape thickness	T	0.20 ± 0.05
Tape width	W	8.00 ± 0.20
Reel width	W1	MAX. 14.50

### ORDER INFORMATION

Package	Reel Size	Quantity
SOT-23	7"	3,000

### MARKING CODE

Part Number	Marking Code
SM2302TDSH	TP



# SM2302TDSH

*N-Channel Enhancement Mode Field Effect Transistor*

## **SUGGESTED SOLDER PAD LAYOUT**

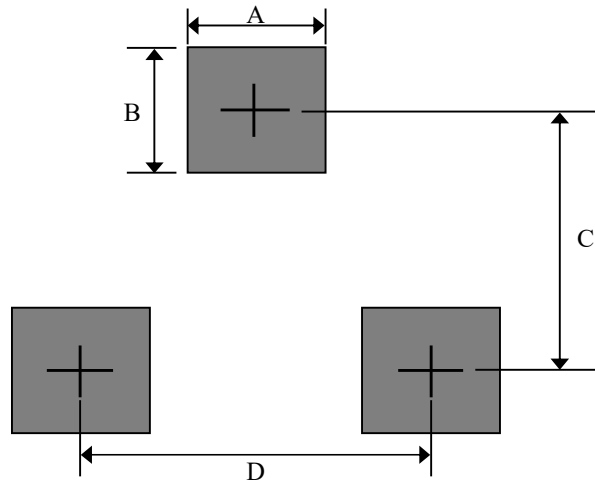

Unit : mm

PACKAGE	A	B	C	D
SOT-23	0.80	1.00	2.40	1.90