



SM2301TDSH

P-Channel Enhancement Mode Field Effect Transistor

FEATURES

· Suffix "H" indicates Halogen-free parts, ex. SM2301TDSH

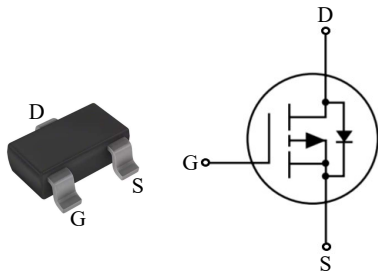

D	Drain
G	Gate
S	Source

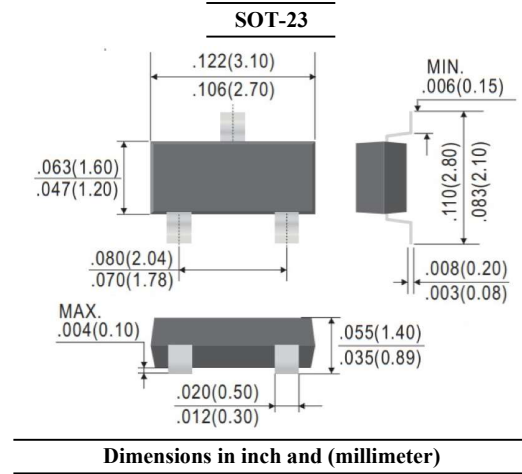

Maximum Ratings ($T_A = 25^\circ\text{C}$ unless otherwise noted)

Parameter	Symbol	Value	Unit
Drain-Source Voltage	V_{DS}	-20	V
Gate-Source Voltage	V_{GS}	± 8	V
Drain Current	I_D	-2.3	A
Pulsed Drain Current (Note 1)	I_{DM}	-10	A
Power Dissipation (Note 2)	P_{tot}	$T_A = 25^\circ\text{C}$	1.25
		$T_A = 75^\circ\text{C}$	0.80
Thermal Resistance from Junction to Ambient	$R_{\theta JA}$	(Note 2)	100
		(Note 3)	166
Operating and Storage Temperature Range	T_J, T_{stg}	- 55 to + 150	$^\circ\text{C}$

Note :

1. Repetitive Rating : Pulse test: pulse width limited by junction temperature $T_{J(MAX)} = 150^\circ\text{C}$.
2. Device mounted on FR-4 substrate PC board, 2oz copper, with 1-inch square copper plate in still air, $t \leq 5\text{sec}$.
3. Device mounted on FR-4 substrate PC board, 2oz copper, with 1-inch square copper plate in still air.



SM2301TDSH

P-Channel Enhancement Mode Field Effect Transistor

Electrical Characteristics ($T_A = 25\text{ }^\circ\text{C}$ unless otherwise specified)

Parameter	Conditions	Symbol	Min.	Typ.	Max.	Unit
Static						
Drain Source Breakdown Voltage	$I_D = -250\mu\text{A}$	V_{DSS}	-20	-	-	V
Gate Threshold Voltage	$V_{GS} = V_{DS}, I_D = -250\mu\text{A}$	$V_{GS(th)}$	-0.45	-	-0.95	V
Zero Gate Voltage Drain Current	$V_{DS} = -20\text{V}$	I_{DSS}	-	-	-1	μA
Gate-Body Leakage Current	$V_{GS} = \pm 8\text{V}$	I_{GSS}	-	-	± 0.1	μA
Drain-Source On-State Resistance	$V_{GS} = -4.5\text{V}, I_D = -2.8\text{A}$	$R_{DS(on)}$	-	-	100	m Ω
	$V_{GS} = -2.5\text{V}, I_D = -2\text{A}$		-	-	150	
Forward Transconductance	$V_{DS} = -5\text{V}, I_D = -4\text{A}$	g_{FS}	-	8	-	S
Dynamic						
Gate Resistance	$f = 1\text{MHz}$	R_g	-	7	-	Ω
Total Gate Charge	$V_{GS} = -4.5\text{V}, V_{DS} = -10\text{V}, I_D = -1\text{A}$	Q_g	-	4.9	-	nC
Gate-Source Charge		Q_{gs}	-	1.4	-	
Gate-Drain Charge		Q_{gd}	-	1.3	-	
Input Capacitance	$V_{DS} = -10\text{V}, V_{GS} = 0\text{V}, f = 1\text{MHz}$	C_{iss}	-	354	-	pF
Output Capacitance		C_{oss}	-	48	-	
Reverse Transfer Capacitance		C_{rss}	-	28	-	
Turn-On Delay Time	$V_{DS} = -10\text{V}, I_D = -1\text{A}, V_{GS} = -4.5\text{V}, R_g = 10\Omega$	$t_{d(on)}$	-	8.4	-	ns
Turn-On Rise Time		t_r	-	11.8	-	
Turn-Off Delay Time		$t_{d(off)}$	-	32.4	-	
Turn-Off Fall Time		t_f	-	17.8	-	
Drain-Source Body Diode						
Drain-Source Diode Forward Voltage	$I_S = -0.75\text{A}, V_{GS} = 0$	V_{SD}	-	-	-1.2	V
Diode Continuous Forward Current	-	I_S	-	-	-2.4	A
Reverse Recovery Time	$I_f = -1\text{A}, di/dt = 100\text{A}/\mu\text{s}$	t_{rr}	-	5.3	-	ns
Reverse Recovery Charge		Q_{rr}	-	1.7	-	nC



SM2301TDSH

P-Channel Enhancement Mode Field Effect Transistor

RATINGS AND CHARACTERISTIC CURVES

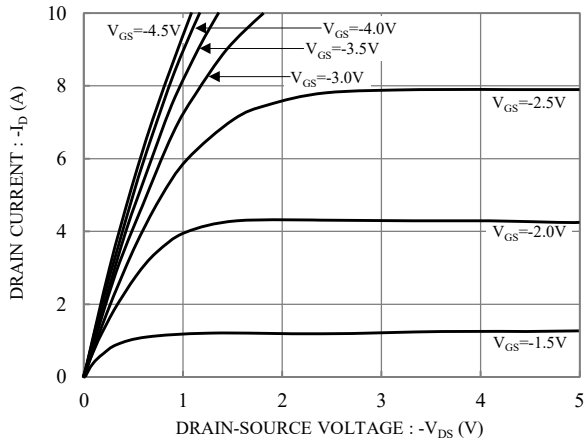

Fig.1 Typical Output Characteristics

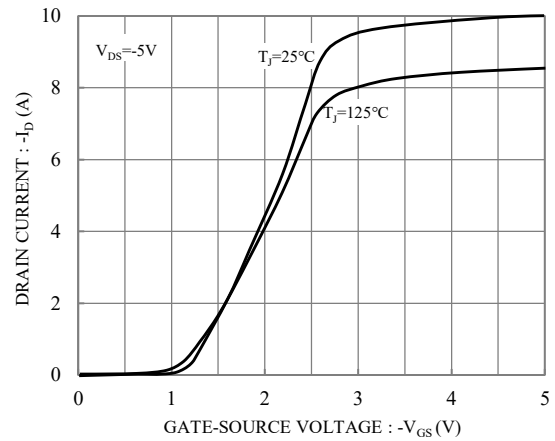

Fig.2 Typical Transfer Characteristics

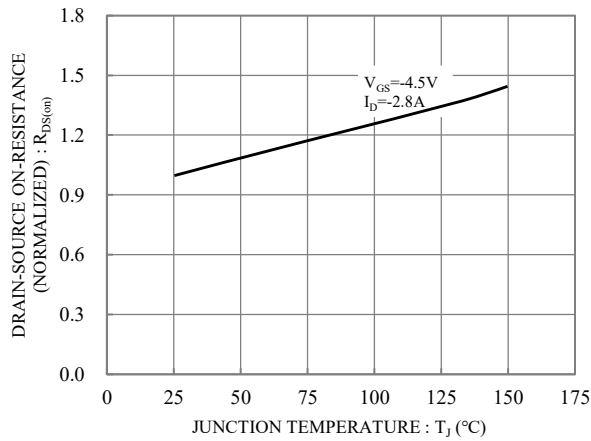

Fig.3 On-Resistance vs. Junction Temperature

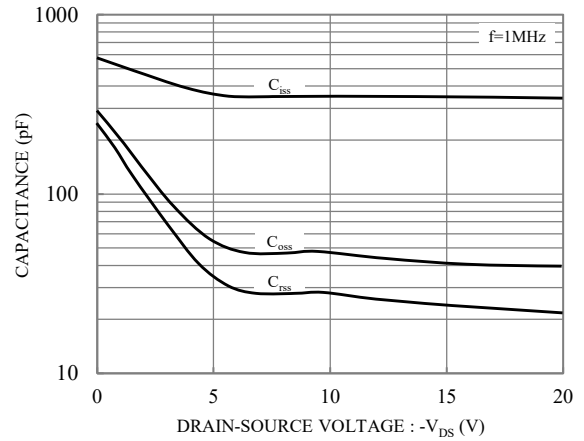

Fig.4 Capacitance vs. Drain-Source Voltage

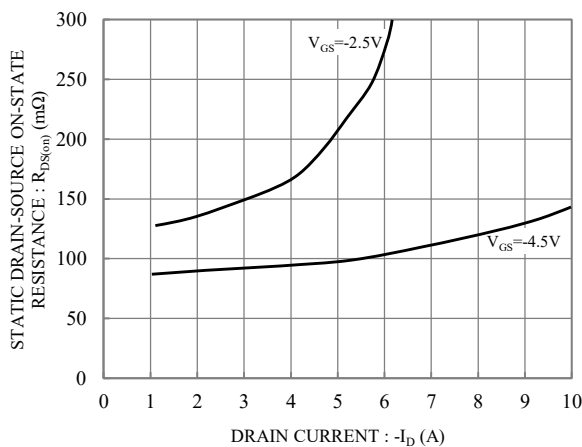

Fig.5 Static Drain-Source On-State Resistance vs. Drain current

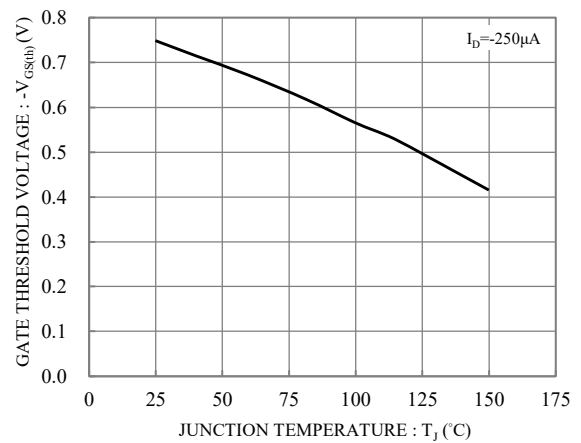

Fig.6 Gate Threshold Voltage vs. Junction Temperature



SM2301TDSH

P-Channel Enhancement Mode Field Effect Transistor

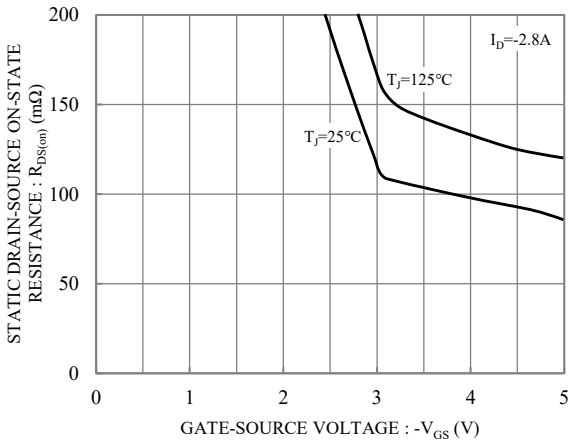

Fig.7 Static Drain-Source On-State Resistance vs Gate-Source Voltage

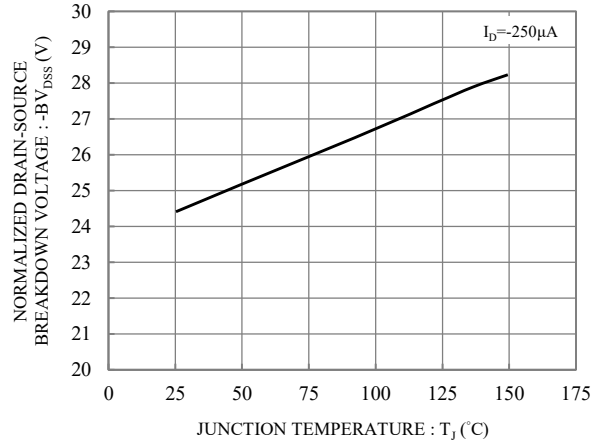

Fig.8 Breakdown Voltage vs Junction Temperature

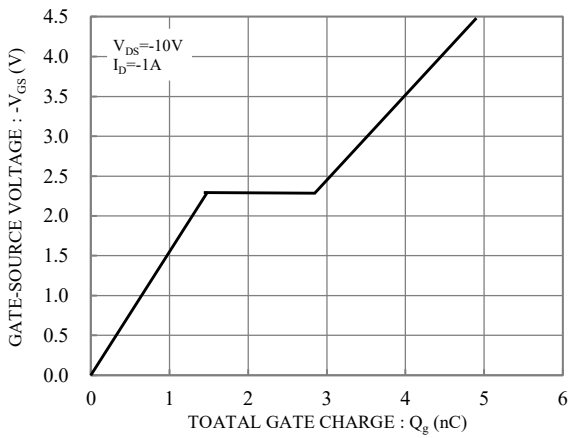

Fig.9 Gate Charge

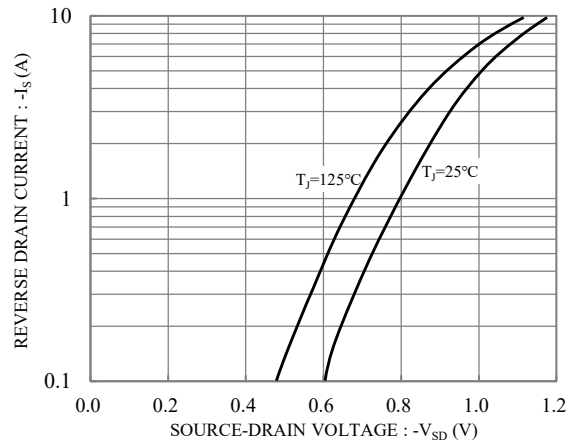

Fig.10 Typical Forward Characteristic

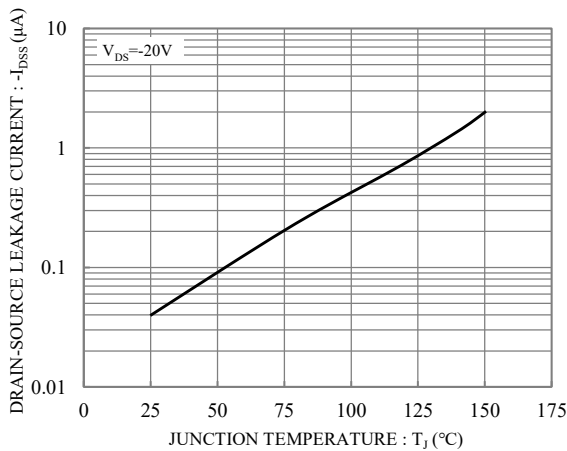

Fig.11 Drain-Source Leakage Current vs Junction Temperature

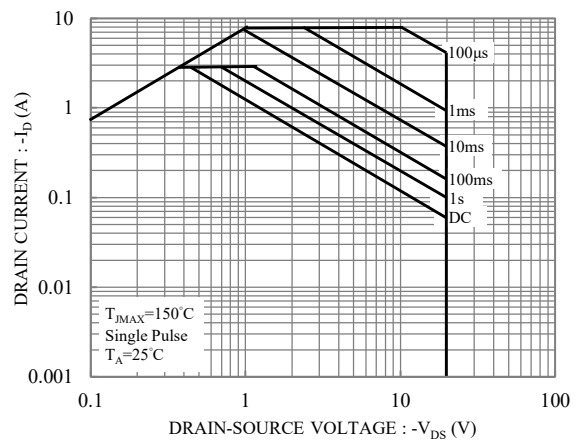

Fig.12 Safe Operation Area



SM2301TDSH

P-Channel Enhancement Mode Field Effect Transistor

TAPE & REEL SPECIFICATION

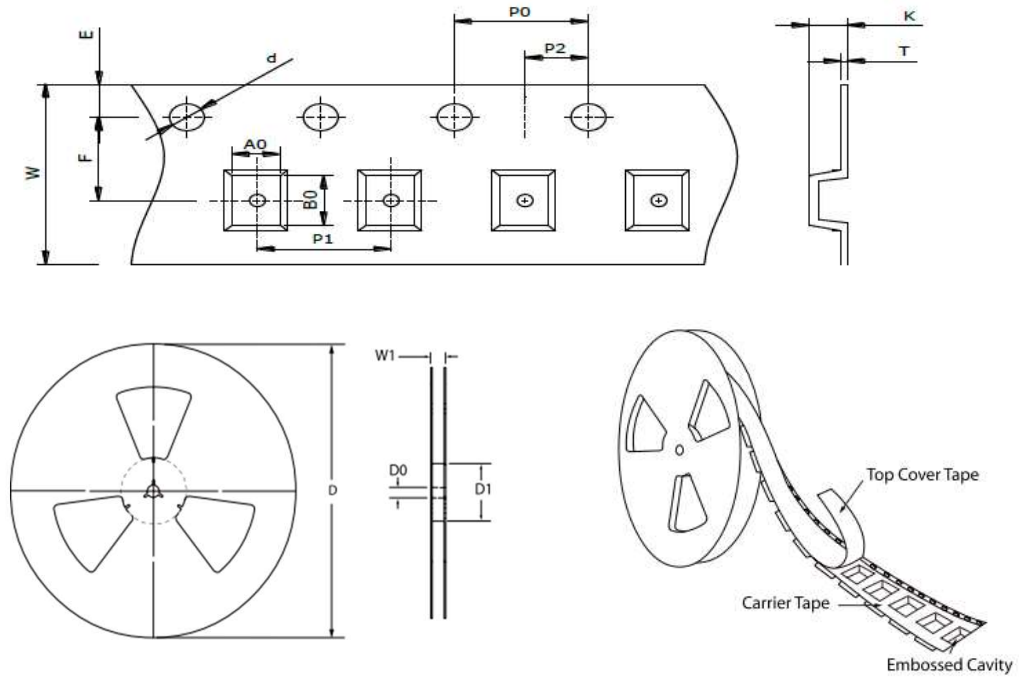

Item	Symbol	SOT-23
Carrier width	A ₀	3.30 ± 0.10
Carrier length	B ₀	3.00 ± 0.10
Carrier depth	K	1.70 ± 0.10
Sprocket hole	d	1.50 ± 0.10
Reel outside diameter	D	178.00 ± 2.00
Feed hole width	D ₀	13.00 ± 0.50
Reel inner diameter	D ₁	MIN. 50.00
Sprocket hole position	E	1.75 ± 0.10
Punch hole position	F	3.50 ± 0.10
Sprocket hole pitch	P ₀	4.00 ± 0.10
Punch hole pitch	P ₁	4.00 ± 0.10
Embossment center	P ₂	2.00 ± 0.10
Overall tape thickness	T	0.20 ± 0.05
Tape width	W	8.00 ± 0.20
Reel width	W1	MAX. 14.50

ORDER INFORMATION

Package	Reel Size	Quantity
SOT-23	7"	3,000

MARKING CODE

Part Number	Marking Code
SM2301TDSH	M01



SM2301TDSH

P-Channel Enhancement Mode Field Effect Transistor

SUGGESTED SOLDER PAD LAYOUT

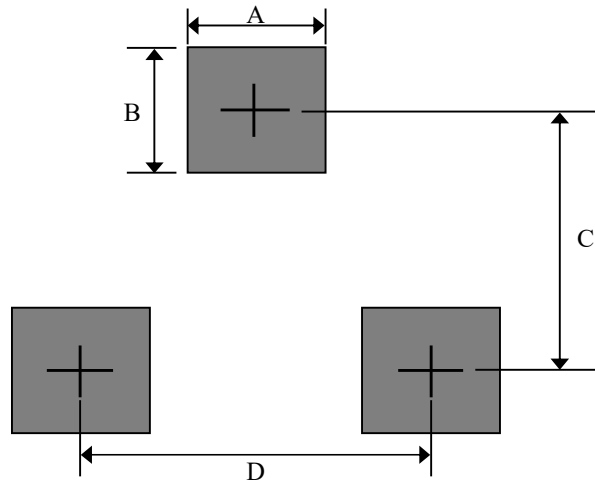

Unit : mm

PACKAGE	A	B	C	D
SOT-23	0.80	1.00	2.40	1.90