



SM1012TKWTH

N-Channel Enhancement Mode Field Effect Transistor

FEATURES

- Low Gate Threshold Voltage
- ESD Protected $\geq 2\text{kV}$
- Low Input Capacitance
- Suffix "H" indicates Halogen-free parts, ex. SM1012TKWTH

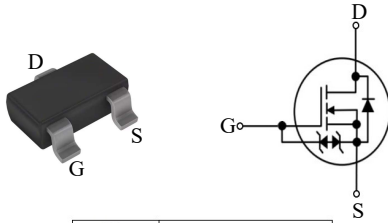

Pin	Description
G	Gate
S	Source
D	Drain

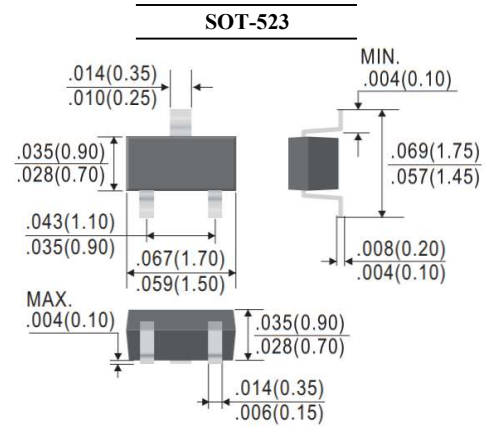

Maximum Ratings ($T_A = 25^\circ\text{C}$ unless otherwise noted)

Parameter	Symbol	Value	Unit
Drain-Source Voltage	V_{DSS}	20	V
Gate-Source Voltage	V_{GSS}	± 8	V
Drain Current	I_D	0.63 0.45	A
		$T_A = 25^\circ\text{C}$ $T_A = 85^\circ\text{C}$	
Pulsed Drain Current	I_{DM}	3	A
Power Dissipation	P_D	0.15	W
		0.28	
Thermal Resistance Junction to Ambient	$R_{\theta JA}$	833	$^\circ\text{C}/\text{W}$
		446	
Operating and Storage Temperature Range	T_J, T_{STG}	- 55 to + 150	$^\circ\text{C}$

Note :

1. Pulse width $\leq 100\mu\text{s}$, Duty cycle $\leq 2\%$, Repetitive rating, pulse width limited by junction temperature $T_{J(MAX)} = 150^\circ\text{C}$
2. Device mounted on FR-4 substrate PC board, 2oz copper, with minimum recommended pad layout
3. Device mounted on FR-4 substrate PC board, 2oz copper, with 1-inch square copper plate in still air



SM1012TKWTH

N-Channel Enhancement Mode Field Effect Transistor

Electrical Characteristics ($T_A=25\text{ }^\circ\text{C}$ unless otherwise specified)

Parameter	Conditions	Symbol	Min.	Typ.	Max.	Unit
Static						
Drain Source Breakdown Voltage	$I_D=250\mu\text{A}$	V_{DSS}	20	-	-	V
Gate Threshold Voltage	$V_{GS}=V_{DS}, I_D=250\mu\text{A}$	$V_{GS(th)}$	0.5	-	1.0	V
Zero Gate Voltage Drain Current	$V_{DS}=20\text{V}$	I_{DSS}	-	-	0.1	μA
Gate-Body Leakage Current	$V_{GS}=\pm 4.5\text{V}$	I_{GSS}	-	-	± 1	μA
	$V_{GS}=\pm 8\text{V}$		-	-	± 10	
Drain-Source On-State Resistance	$V_{GS}=4.5\text{V}, I_D=0.6\text{A}$	$R_{DS(on)}$	-	-	0.4	Ω
	$V_{GS}=2.5\text{V}, I_D=0.5\text{A}$		-	-	0.5	
	$V_{GS}=1.8\text{V}, I_D=0.35\text{A}$		-	-	0.7	
Forward Transfer Admittance	$V_{DS}=10\text{V}, I_D=0.4\text{A}$	$ y_{fs} $	-	1.4	-	S
Dynamic						
Total Gate Charge	$V_{DS}=10\text{V}, I_D=1\text{A}, V_{GS}=2.5\text{V}$	Q_g	-	0.6	-	nC
			-	1.1	-	
Gate Source Charge	$V_{DS}=10\text{V}, I_D=1\text{A}, V_{GS}=4.5\text{V}$	Q_{gs}	-	0.3	-	
Gate Drain Charge		Q_{gd}	-	0.2	-	
Input Capacitance	$V_{DS}=10\text{V}, V_{GS}=0\text{V}, f=1\text{MHz}$	C_{iss}	-	72	-	pF
Output Capacitance		C_{oss}	-	14	-	
Reverse Transfer Capacitance		C_{rss}	-	12	-	
Turn-On Delay Time		$t_{d(on)}$	-	12	-	
Turn-On Rise Time	$V_{DS}=10\text{V}, V_{GS}=4.5\text{V}, I_D=0.5\text{A}, R_G=10\Omega$	t_r	-	6	-	
Turn-Off Delay Time		$t_{d(off)}$	-	13	-	
Turn-Off Fall Time	t_f	-	10	-		
Drain-Source Body Diode						
Drain-Source Diode Forward Voltage	$V_{GS}=0\text{V}, I_S=0.15\text{A}$	V_{SD}	-	-	1.2	V
Reverse Recovery Time	$I_S=1\text{A}, di/dt=100\text{A}/\mu\text{s}$	t_{rr}	-	5.2	-	ns
Reverse Recovery Charge		Q_{rr}	-	1.2	-	nC



SM1012TKWTH

N-Channel Enhancement Mode Field Effect Transistor

RATINGS AND CHARACTERISTIC CURVES

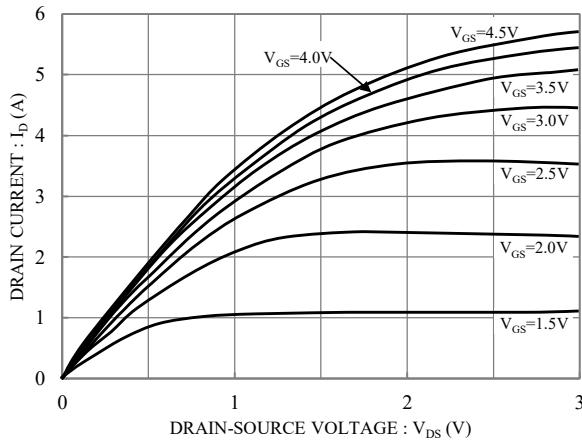

Fig.1 Typical output characteristics

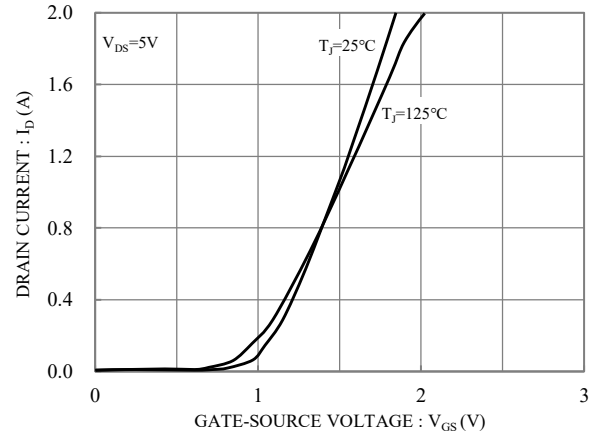

Fig.2 Typical transfer characteristics

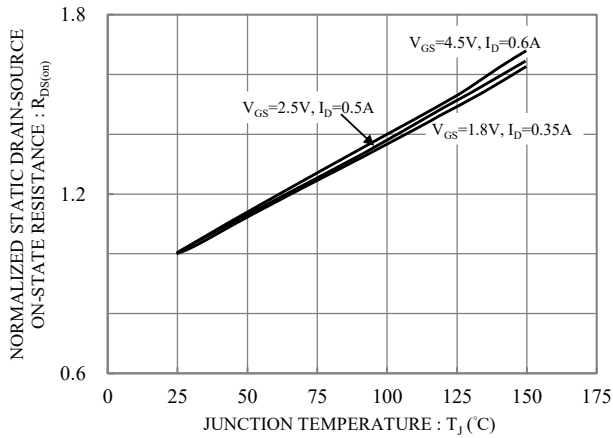

Fig.3 Drain-Source On-State Resistance vs. Junction Temperature

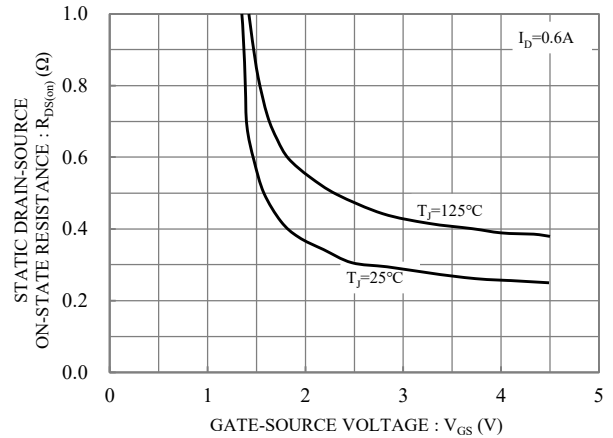

Fig.4 Static drain-source on-state resistance vs. gate-source voltage

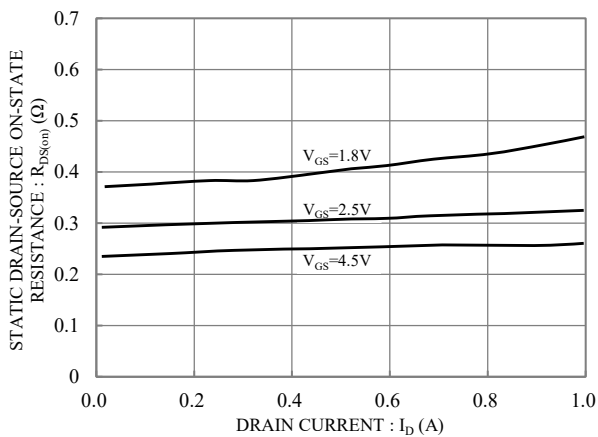

Fig.5 Static drain-source on-state resistance vs. Drain current

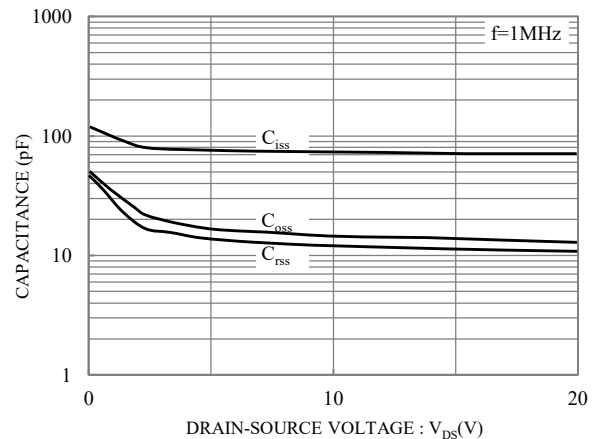

Fig.6 Capacitance vs. Drain-to-Source Voltage



SM1012TKWTH

N-Channel Enhancement Mode Field Effect Transistor

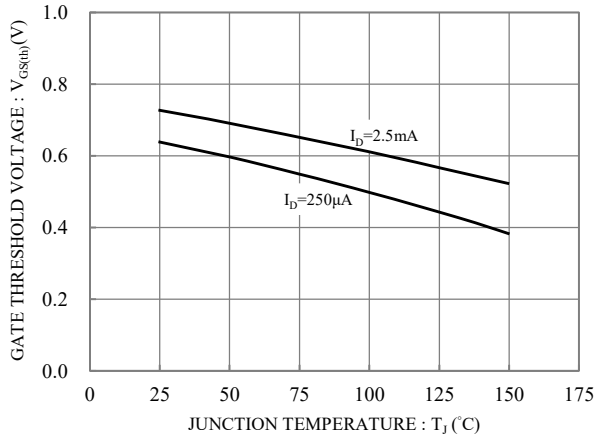

Fig.7 Threshold Voltage vs Junction Temperature

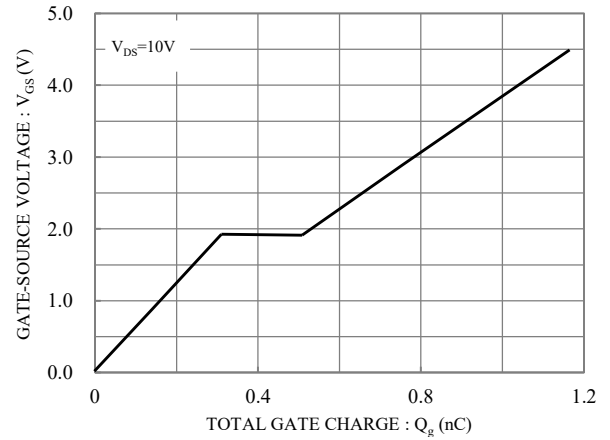

Fig.8 Gate Charge Characteristics

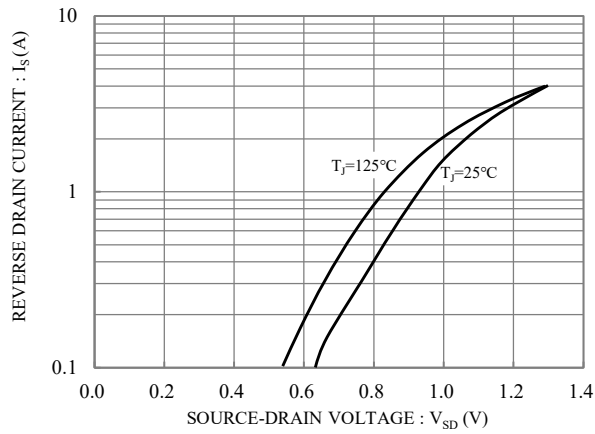

Fig.9 Typical Forward Characteristic

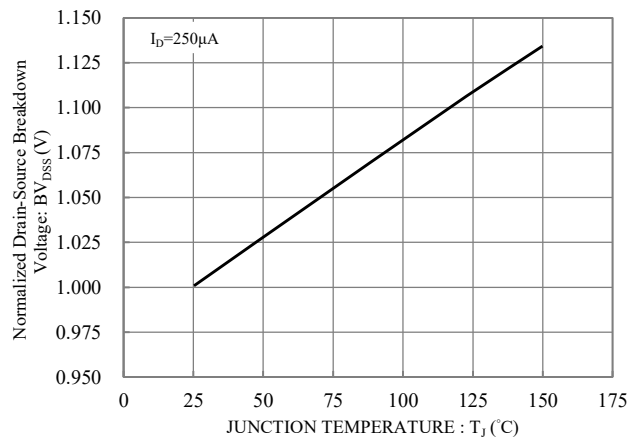

Fig.10 Breakdown Voltage vs Junction Temperature



SM1012TKWTH

N-Channel Enhancement Mode Field Effect Transistor

TAPE & REEL SPECIFICATION

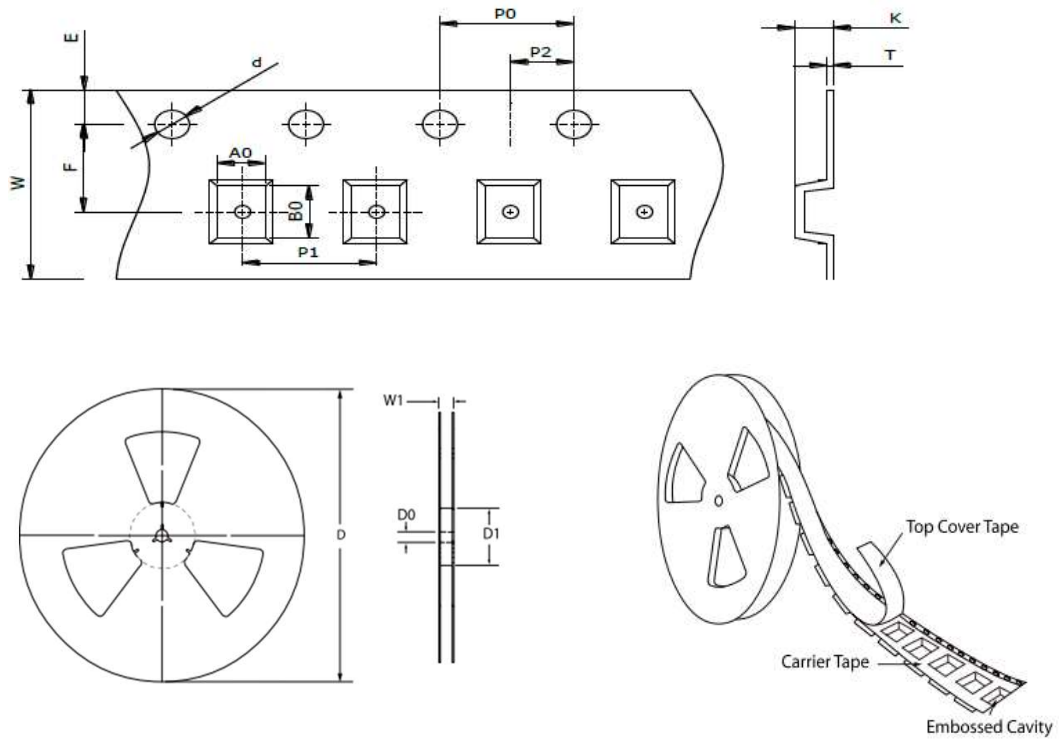

Item	Symbol	SOT-523
Carrier width	A ₀	1.95 ± 0.10
Carrier length	B ₀	1.90 ± 0.10
Carrier depth	K	1.20 ± 0.10
Sprocket hole	d	1.50 ± 0.10
Reel outside diameter	D	178.00 ± 2.00
Feed hole width	D ₀	13.00 ± 0.50
Reel inner diameter	D ₁	MIN. 50.00
Sprocket hole position	E	1.75 ± 0.10
Punch hole position	F	3.50 ± 0.10
Sprocket hole pitch	P ₀	4.00 ± 0.10
Punch hole pitch	P ₁	4.00 ± 0.10
Embossment center	P ₂	2.00 ± 0.10
Overall tape thickness	T	0.20 ± 0.05
Tape width	W	8.00 ± 0.20
Reel width	W1	MAX. 14.50

ORDER INFORMATION

Package	Reel Size	Quantity
SOT-523	7"	4,000

MARKING CODE

Part Number	Marking Code
SM1012TKWTH	MF



SM1012TKWTH

N-Channel Enhancement Mode Field Effect Transistor

SUGGESTED SOLDER PAD LAYOUT

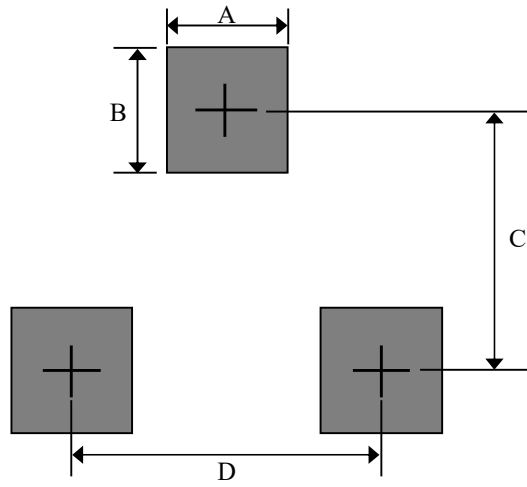

Unit : mm

PACKAGE	A	B	C	D
SOT-523	0.70	0.70	1.30	1.00