



SM03P095TTDSH

P-Channel Enhancement Mode Field Effect Transistor

FEATURES

· Suffix "H" indicates Halogen-free parts, ex. SM03P095TTDSH

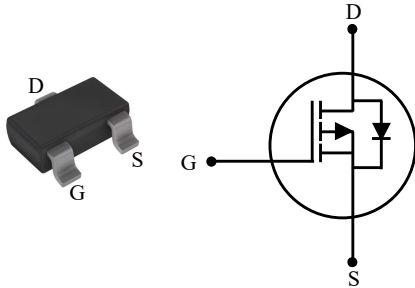

D	Drain
G	Gate
S	Source

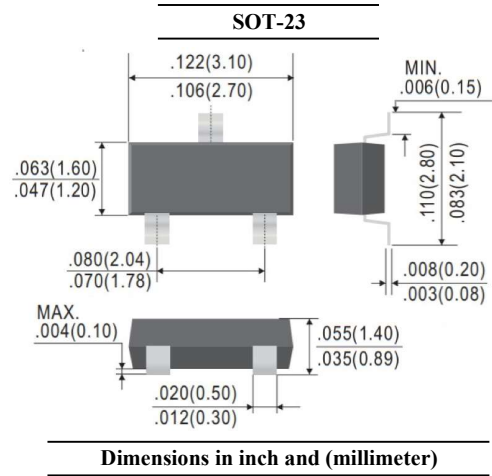

Maximum Ratings ($T_A = 25\text{ }^\circ\text{C}$ unless otherwise noted)

Parameter	Symbol	Value	Unit
Drain-Source Voltage	V_{DS}	-30	V
Gate-Source Voltage	V_{GS}	± 20	V
Drain Current	I_D	-3.9	A
Pulsed Drain Current (Note 1)	I_{DM}	-17	A
Power Dissipation (Note 2)	Steady State	0.60	W
	$t \leq 10\text{s}$	1.38	
Thermal Resistance from Junction to Ambient (Note 2)	Steady State	208.0	$^\circ\text{C}/\text{W}$
	$t \leq 10\text{s}$	90.5	
Operating and Storage Temperature Range	T_J, T_{stg}	- 55 to + 150	$^\circ\text{C}$

Note :

1. Pulse width $\leq 100\mu\text{s}$, Duty Cycle $\leq 2\%$, Repetitive rating, pulse width limited by junction temperature $T_{J(\text{MAX})} = 150\text{ }^\circ\text{C}$
2. Device mounted on FR-4 substrate PC board, 2oz copper, with 1-inch² copper plate in still air



SM03P095TTDSH

P-Channel Enhancement Mode Field Effect Transistor

Electrical Characteristics ($T_A = 25\text{ }^\circ\text{C}$ unless otherwise specified)

Parameter	Conditions	Symbol	Min.	Typ.	Max.	Unit
Static						
Drain Source Breakdown Voltage	$I_D = -250\mu\text{A}$	V_{DSS}	-30	-	-	V
Gate Threshold Voltage	$V_{DS} = V_{GS}, I_D = -250\mu\text{A}$	$V_{GS(th)}$	-1.0	-	-2.5	V
Zero Gate Voltage Drain Current	$V_{DS} = -24\text{V}$	I_{DSS}	-	-	-1	μA
Gate-Body Leakage Current	$V_{GS} = \pm 20\text{V}$	I_{GSS}	-	-	± 0.1	μA
Drain-Source On-State Resistance	$V_{GS} = -10\text{V}, I_D = -3.9\text{A}$	$R_{DS(on)}$	-	-	72	m Ω
	$V_{GS} = -4.5\text{V}, I_D = -3\text{A}$		-	95	110	
Dynamic						
Forward Transfer Admittance	$V_{DS} = -10\text{V}, I_D = -2\text{A}$	g_{FS}	-	3	-	S
Gate resistance	$V_{DS} = 0\text{V}, f = 1\text{MHz}$	R_g	-	6	-	Ω
Total Gate Charge	$V_{DS} = -20\text{V}, I_D = -3\text{A}, V_{GS} = -4.5\text{V}$	Q_g	-	4.0	-	nC
			-	8.3	-	
Gate-Source Charge	$V_{DS} = -20\text{V}, I_D = -3\text{A}, V_{GS} = -10\text{V}$	Q_{gs}	-	1.8	-	
Gate-Drain Charge		Q_{gd}	-	1.2	-	
Input Capacitance	$V_{DS} = -20\text{V}, V_{GS} = 0\text{V}, f = 1\text{MHz}$	C_{iss}	-	410	-	pF
Output Capacitance		C_{oss}	-	47	-	
Reverse Transfer Capacitance		C_{rss}	-	40	-	
Turn-On Delay Time		$t_{d(on)}$	-	7.6	-	
Turn-On Rise Time	$V_{GS} = -10\text{V}, V_{DD} = -20\text{V},$ $I_D = -3\text{A}, R_g = 3.3\Omega$	t_r	-	13.0	-	
Turn-Off Delay Time	$t_{d(off)}$	-	9.6	-		
Turn-Off Fall Time	t_f	-	2.8	-		
Drain-Source Body Diode						
Drain-Source Diode Forward Voltage	$I_S = -1\text{A}$	V_{SD}	-	-	-1.2	V
Reverse Recovery Time	$I_S = -3\text{A}, di/dt = 100\text{A}/\mu\text{s}$	t_{rr}	-	9	-	ns
Reverse Recovery Charge		Q_{rr}	-	5	-	nC



SM03P095TTDSH

P-Channel Enhancement Mode Field Effect Transistor

RATINGS AND CHARACTERISTIC CURVES

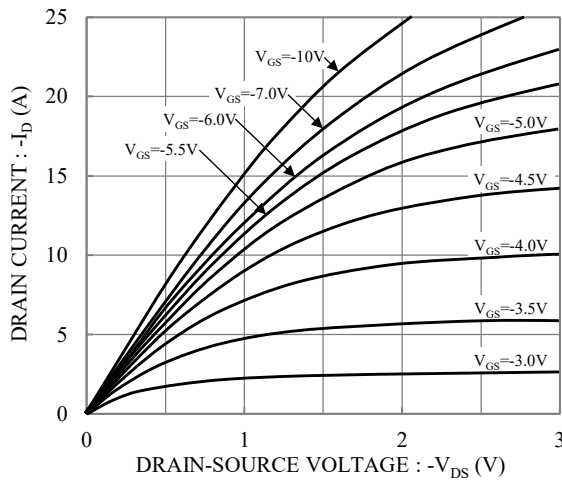

Fig.1 Typical Output Characteristics

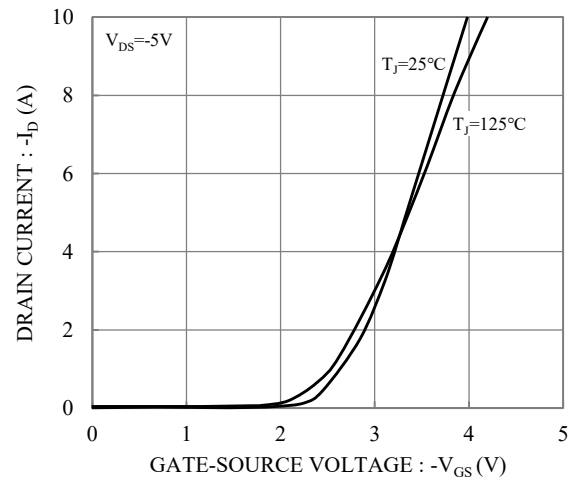

Fig.2 Typical Transfer Characteristics

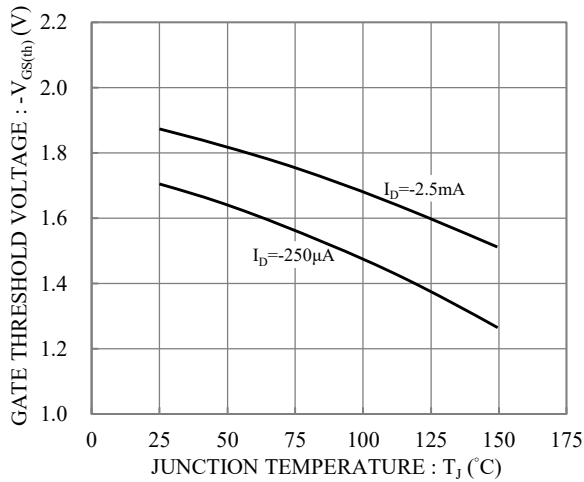

Fig.3 Gate Threshold Voltage vs. Junction Temperature

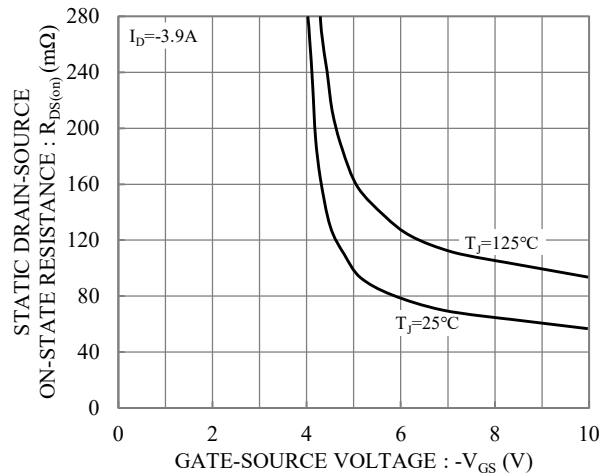

Fig.4 Static Drain-Source On-State Resistance vs. Gate-Source Voltage

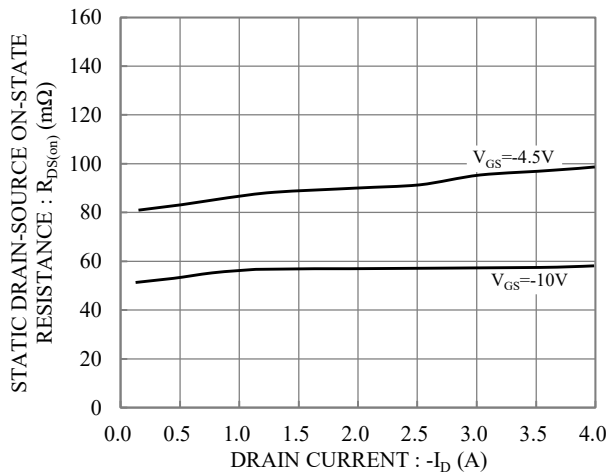

Fig.5 Static Drain-Source On-State Resistance vs. Drain Current

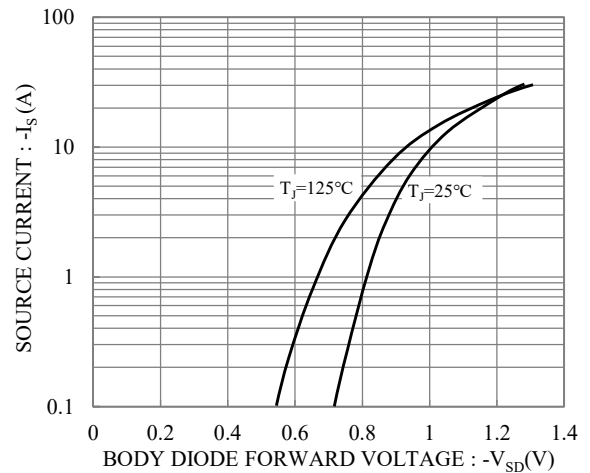

Fig.6 Body Diode Forward Voltage vs. Source Current



SM03P095TTDSH

P-Channel Enhancement Mode Field Effect Transistor

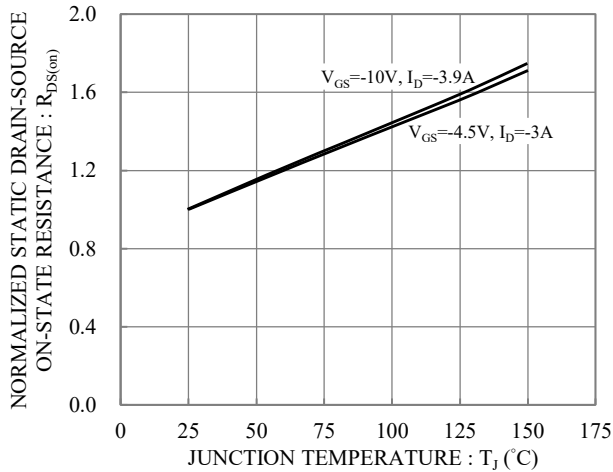

Fig.7 Drain-Source On-State Resistance vs Junction Temperature

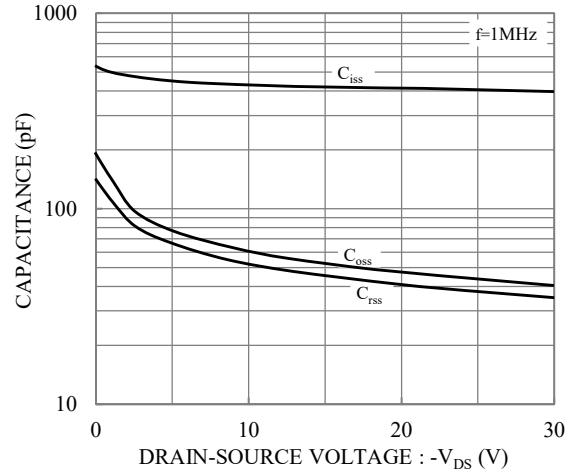

Fig.8 Capacitance vs Drain-Source Voltage

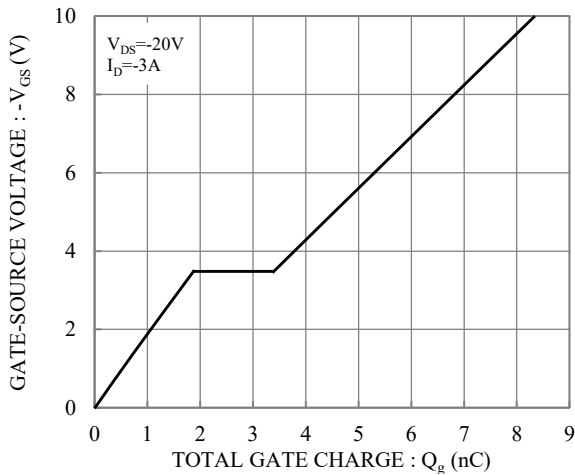

Fig.9 Gate Charge

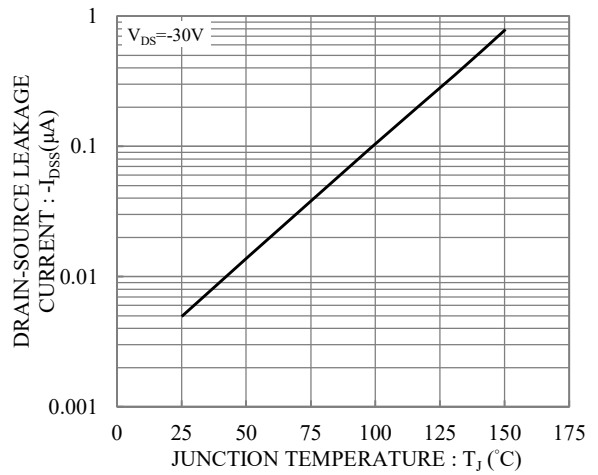

Fig.10 Drain-Source Leakage Current vs. Junction Temperature

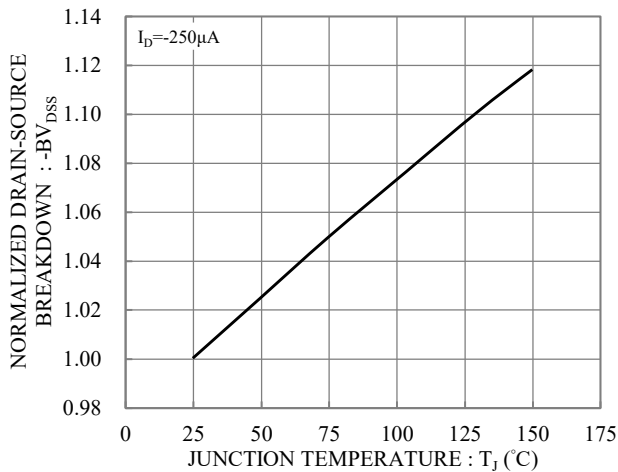

Fig.11 Brekdown Voltage vs. Junction Temperature



SM03P095TTDSH

P-Channel Enhancement Mode Field Effect Transistor

TAPE & REEL SPECIFICATION

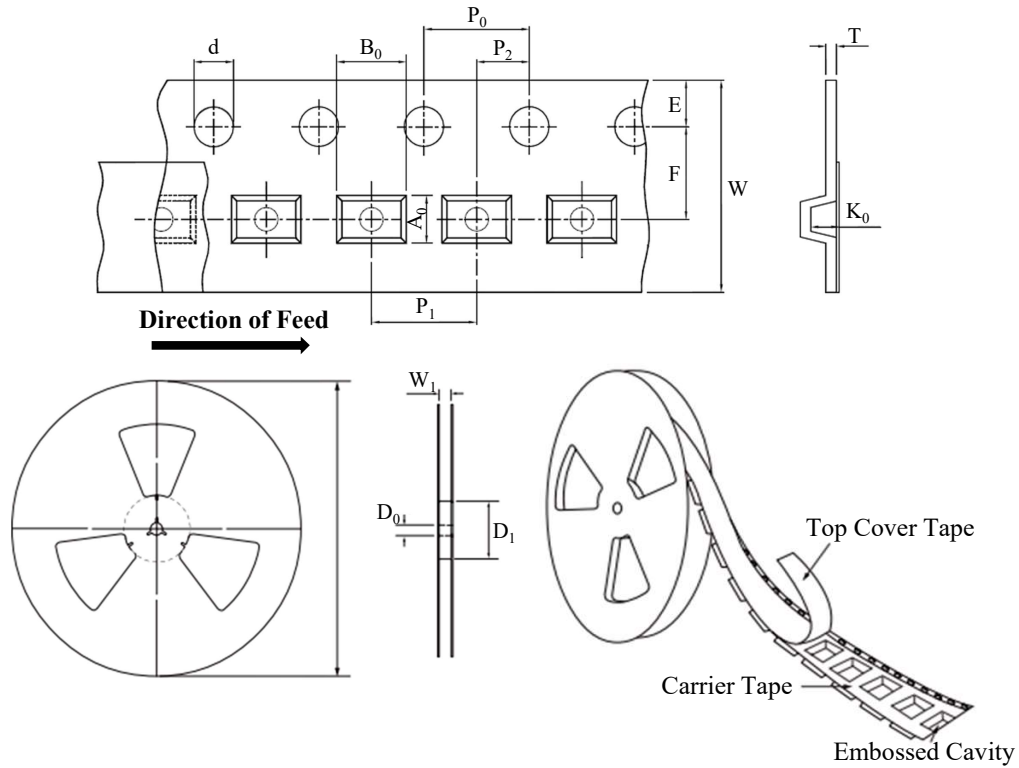

Item	Symbol	SOT-23
Carrier width	A ₀	3.30 ± 0.10
Carrier length	B ₀	3.00 ± 0.10
Carrier depth	K ₀	1.70 ± 0.10
Sprocket hole	d	1.50 ± 0.10
Reel outside diameter	D	178.00 ± 2.00
Feed hole width	D ₀	13.00 ± 0.50
Reel inner diameter	D ₁	MIN. 50.00
Sprocket hole position	E	1.75 ± 0.10
Punch hole position	F	3.50 ± 0.10
Sprocket hole pitch	P ₀	4.00 ± 0.10
Punch hole pitch	P ₁	4.00 ± 0.10
Embossment center	P ₂	2.00 ± 0.10
Overall tape thickness	T	0.20 ± 0.05
Tape width	W	8.00 ± 0.20
Reel width	W ₁	MAX. 14.50

ORDER INFORMATION

Package	Reel Size	Quantity
SOT-23	7"	3,000

MARKING CODE

Part Number	Marking Code
SM03P095TTDSH	N7



SM03P095TTDSH

P-Channel Enhancement Mode Field Effect Transistor

SUGGESTED SOLDER PAD LAYOUT

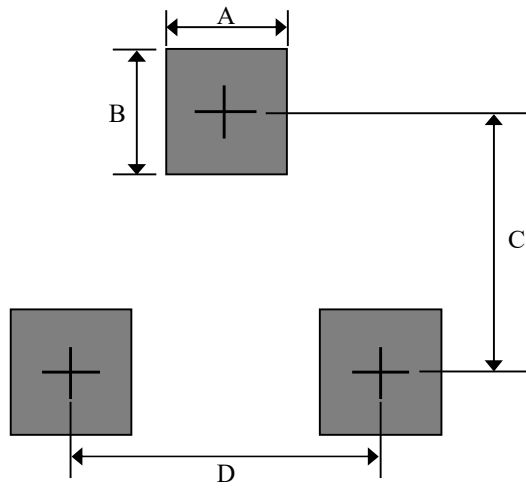

Unit : mm

PACKAGE	A	B	C	D
SOT-23	0.80	1.00	2.40	1.90