



MMBT9015 BH / CH / DH

PNP TRANSISTORS

RATINGS AND CHARACTERISTIC CURVES

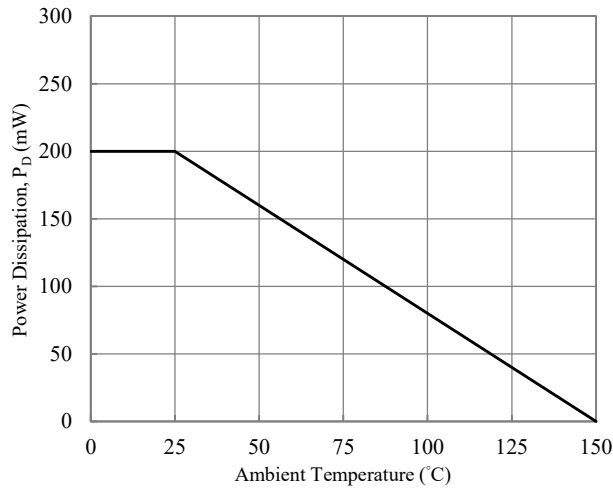

Fig. 1 Power Derating Curves

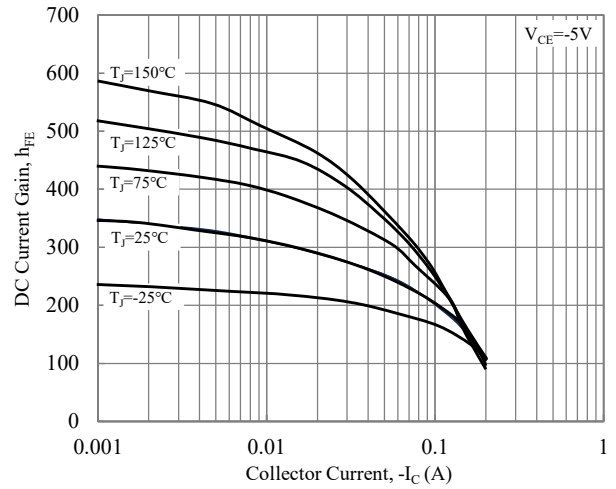

Fig. 2 Current Gain vs. Collector Current

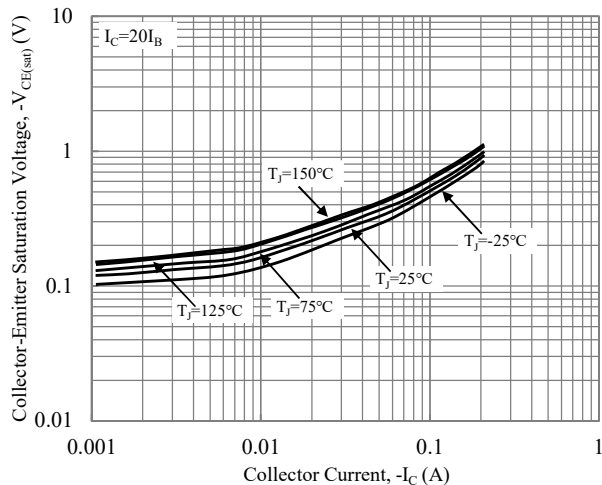

Fig. 3 Collector-Emitter Saturation Voltage vs. Collector Current

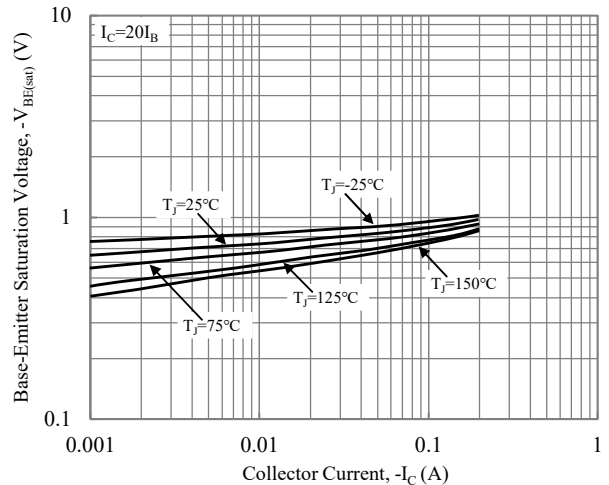

Fig. 4 Base-Emitter Saturation Voltage vs. Collector Current

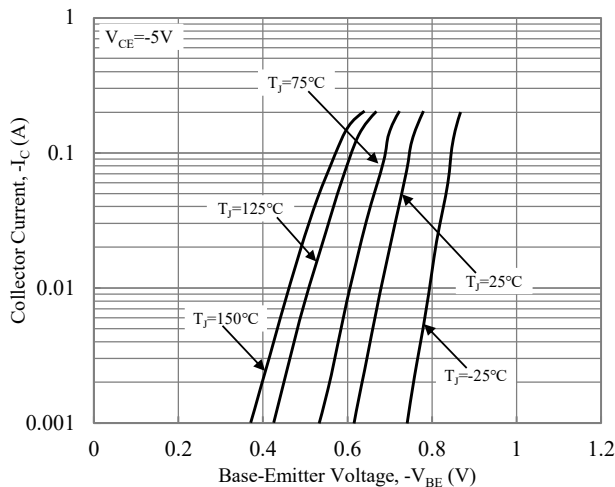

Fig. 5 Base-Emitter Voltage vs. Collector Current

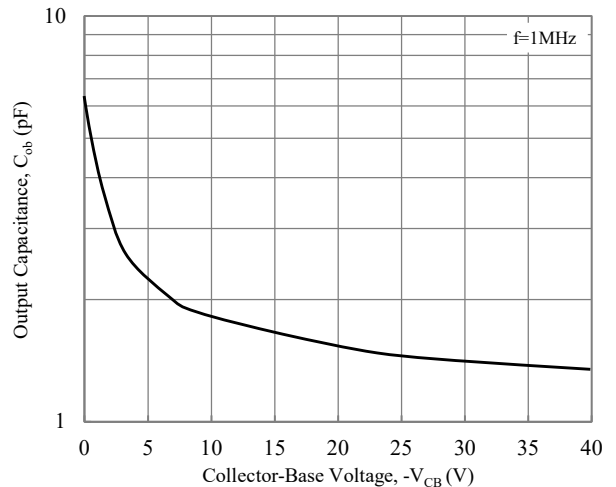

Fig. 6 Output Capacitance



MMBT9015 BH / CH / DH

PNP TRANSISTORS

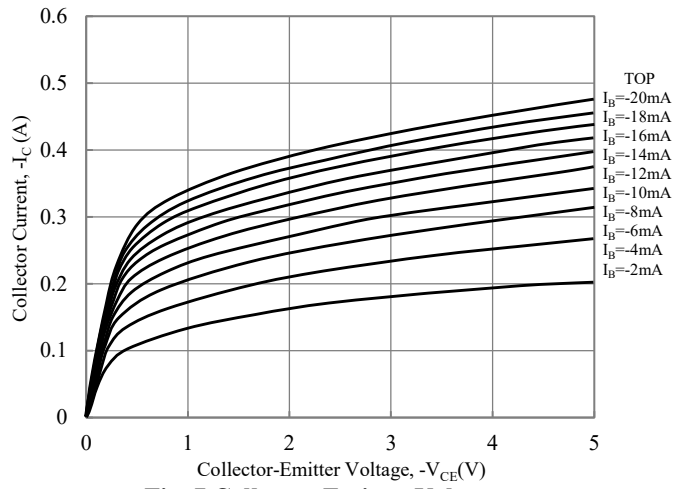

Fig. 7 Collector-Emitter Voltage vs. Collector Current



MMBT9015 BH / CH / DH

PNP TRANSISTORS

TAPE & REEL SPECIFICATION

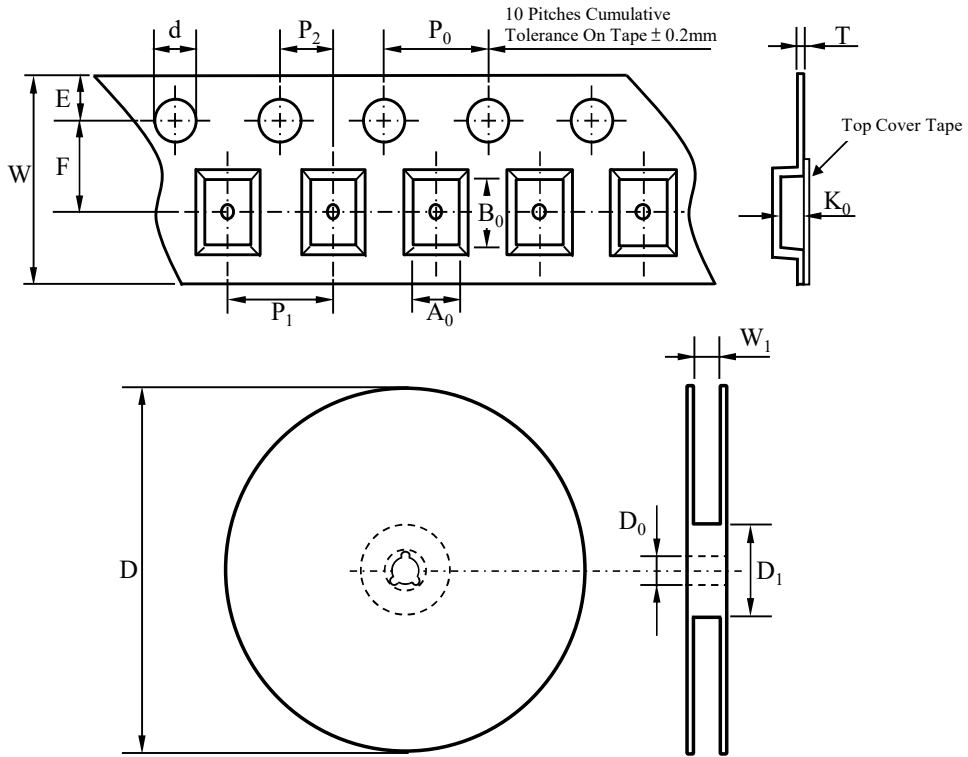

Item	Symbol	SOT-23
Carrier width	A_0	*
Carrier length	B_0	
Carrier depth	K_0	
Sprocket hole	d	1.50 ± 0.10
Reel outside diameter	D	178.00 ± 2.00
Feed hole width	D_0	13.00 ± 0.50
Reel inner diameter	D_1	MIN. 50.00
Sprocket hole position	E	1.75 ± 0.10
Punch hole position	F	3.50 ± 0.10
Sprocket hole pitch	P_0	4.00 ± 0.10
Punch hole pitch	P_1	4.00 ± 0.10
Embossment center	P_2	2.00 ± 0.10
Overall tape thickness	T	0.20 ± 0.05
Tape width	W	8.00 ± 0.20
Reel width	W_1	MAX. 14.50

Note *: A_0 , B_0 , and K_0 are determined by component size. The clearance between the components and the cavity must be within 0.05 mm min. to 0.5 mm max.

ORDER INFORMATION

Part Number	Marking Code	Reel Size	Quantity
MMBT9015BH	3E	7"	3,000
MMBT9015CH	3F		
MMBT9015DH	3G		



MMBT9015 BH / CH / DH

PNP TRANSISTORS

SUGGESTED SOLDER PAD LAYOUT

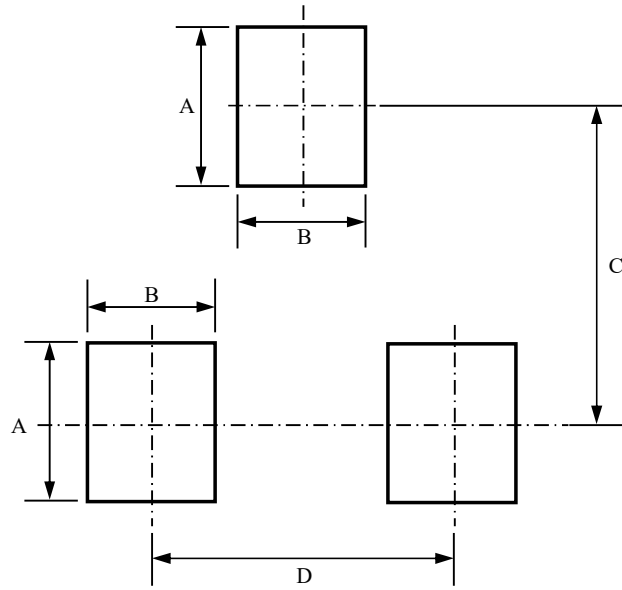

Unit :mm

PACKAGE	A	B	C	D
SOT-23	1.00	0.80	2.00	1.90