



ABC846AWH / ABC846BWH / ABC846CWH

NPN TRANSISTORS

FEATURES

- AEC-Q101 qualified.
- Suffix "H" indicates Halogen-free parts, ex.ABC846AWH.

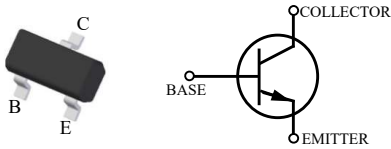

B	Base
C	Collector
E	Emitter

SOT-323

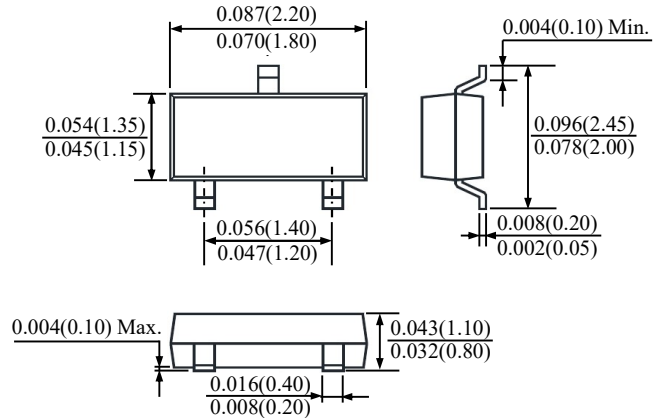

Dimensions in inch and (millimeter)

Maximum Ratings ($T_A = 25\text{ }^\circ\text{C}$ unless otherwise noted)

Parameter	Symbol	Value	Unit
Collector Base Voltage	V_{CBO}	80	V
Collector Emitter Voltage	V_{CEO}	65	V
Emitter Base Voltage	V_{EBO}	6	V
Collector Current	I_C	100	mA
Peak Collector Current	I_{CM}	200	mA
Power Dissipation	P_D	200	mW
Thermal Resistance from Junction to Ambient (Note 1)	$R_{\theta JA}$	625	$^\circ\text{C}/\text{W}$
Junction Temperature	T_J	150	$^\circ\text{C}$
Storage Temperature Range	T_{stg}	- 55 to + 150	$^\circ\text{C}$

Note :

1. Device mounted on FR-4 substrate PC board, 2oz copper, with minimum recommended pad layout.



ABC846AWH / ABC846BWH / ABC846CWH

NPN TRANSISTORS

Electrical Characteristics ($T_A=25\text{ }^\circ\text{C}$ unless otherwise specified)

Parameter	Conditions	Symbol	Min.	Min.	Max.	Unit
DC Current Gain	$V_{CE}=5\text{V}, I_C=2\text{mA}$	A	110	-	220	
		B	200	-	450	-
		C	420	-	800	
Collector Base Cutoff Current	$V_{CB}=30\text{V}$	I_{CBO}	-	-	15	nA
Emitter Base Cutoff Current	$V_{EB}=5\text{V}$	I_{EBO}	-	-	100	nA
Collector Base Breakdown Voltage	$I_C=10\mu\text{A}$	$V_{(BR)CBO}$	80	-	-	V
Collector Emitter Breakdown Voltage	$I_C=10\text{mA}$	$V_{(BR)CEO}$	65	-	-	V
Emitter Base Breakdown Voltage	$I_E=1\mu\text{A}$	$V_{(BR)EBO}$	6	-	-	V
Collector Emitter Saturation Voltage	$I_C=10\text{mA}, I_B=0.5\text{mA}$	$V_{CE(sat)}$	-	-	0.25	V
	$I_C=100\text{mA}, I_B=5\text{mA}$		-	-	0.60	
Base Emitter On Voltage	$V_{CE}=5\text{V}, I_C=2\text{mA}$	$V_{BE(on)}$	0.58	-	0.70	V
	$V_{CE}=5\text{V}, I_C=10\text{mA}$		-	-	0.77	
Transition Frequency	$V_{CE}=5\text{V}, I_C=10\text{mA}, f=100\text{MHz}$	f_T	100	-	-	MHz
Collector Output Capacitance	$V_{CB}=10\text{V}, I_E=0\text{V}, f=1\text{MHz}$	C_{ob}	-	-	4.5	pF



RATINGS AND CHARACTERISTIC CURVES

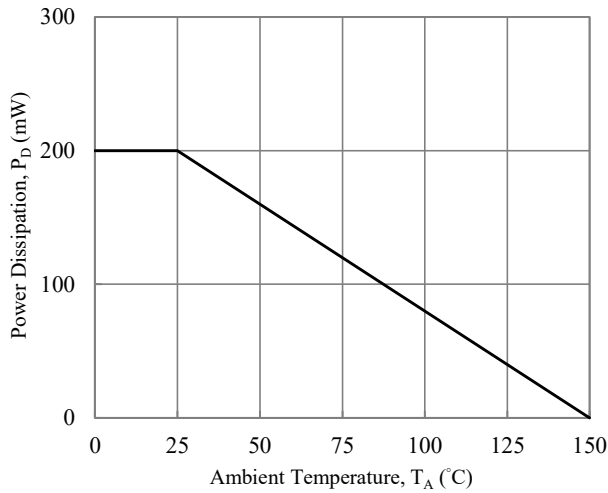

Fig. 1 Power Derating Curves

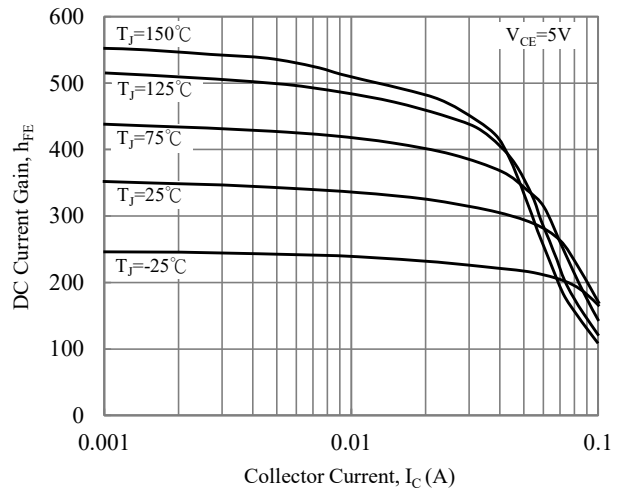

Fig. 2 Current Gain vs. Collector Current

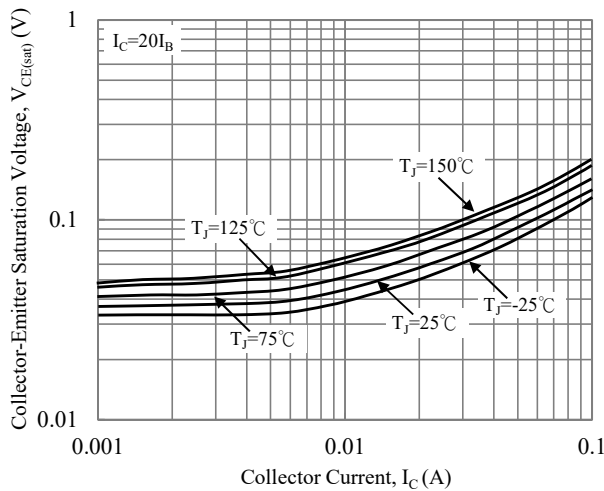

Fig. 3 Collector-Emitter Saturation Voltage vs. Collector Current

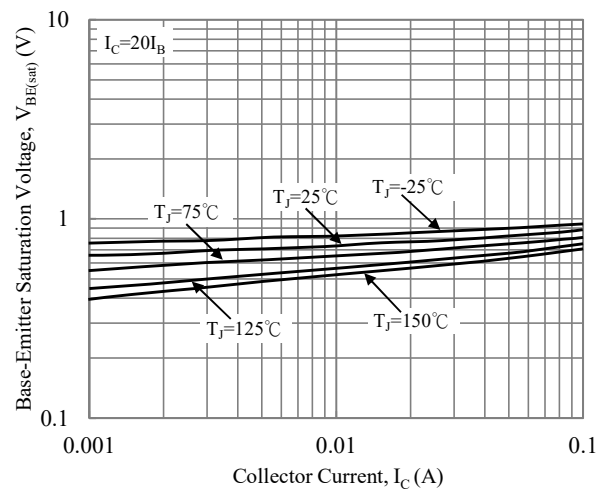

Fig. 4 Base-Emitter Saturation Voltage vs. Collector Current

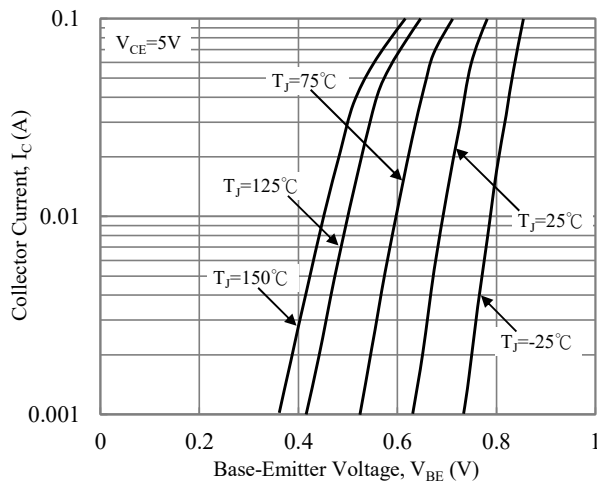

Fig. 5 Base-Emitter Voltage vs. Collector Current

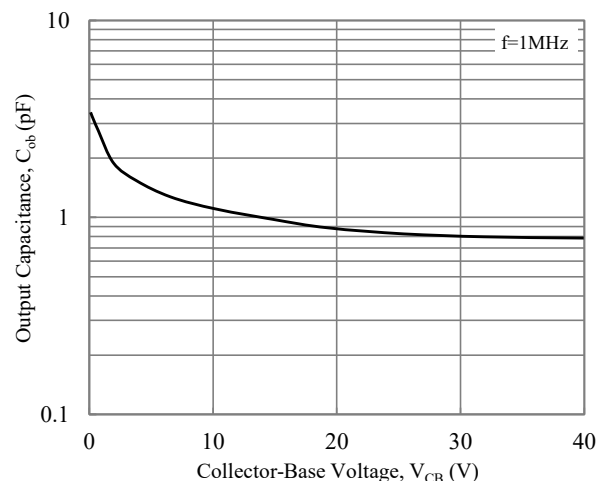

Fig. 6 Output Capacitance

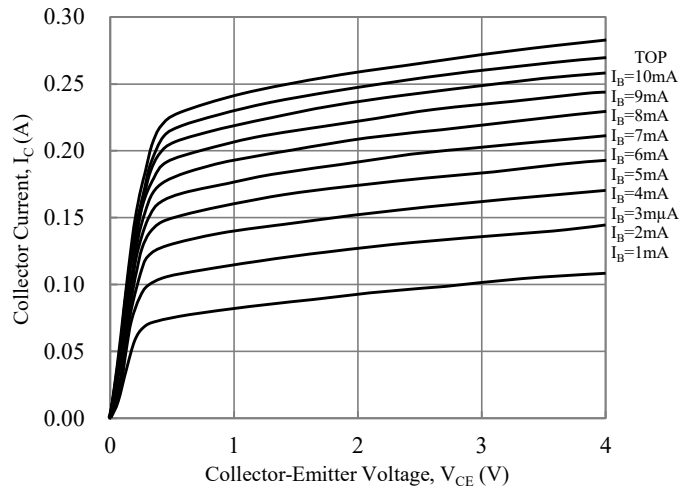

Fig. 7 Output Characteristics Curves



ABC846AWH / ABC846BWH / ABC846CWH

NPN TRANSISTORS

TAPE & REEL SPECIFICATION

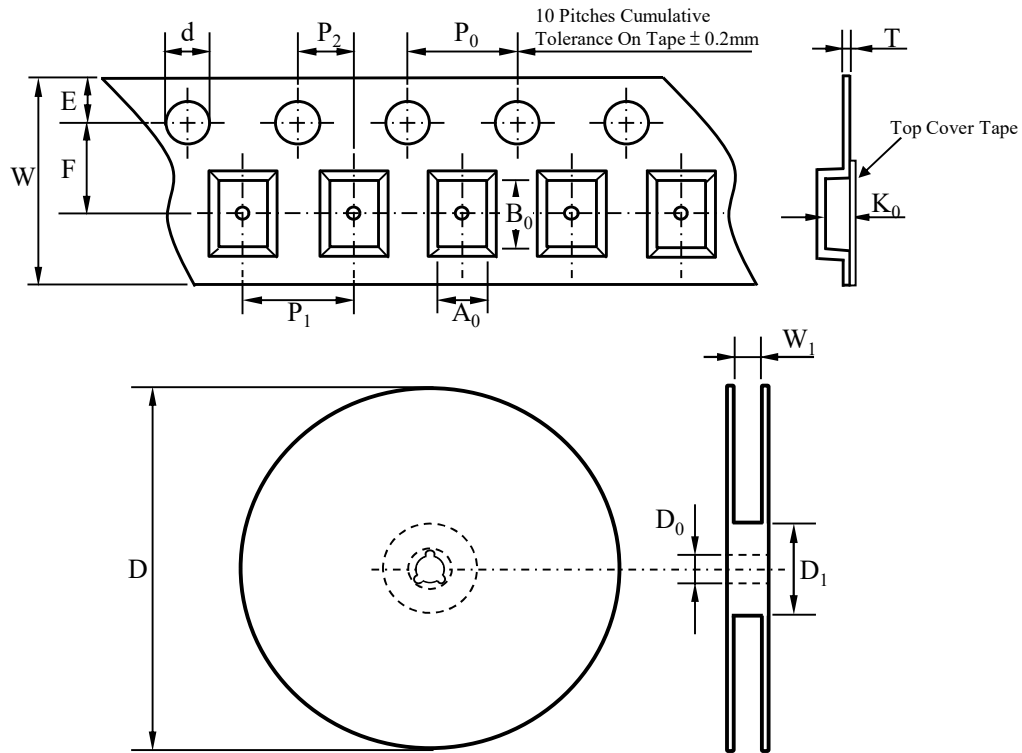

Item	Symbol	SOT-323
Carrier width	A_0	*
Carrier length	B_0	
Carrier depth	K_0	
Sprocket hole	d	1.50 ± 0.10
Reel outside diameter	D	178.00 ± 2.00
Feed hole width	D_0	13.00 ± 0.50
Reel inner diameter	D_1	MIN. 50.00
Sprocket hole position	E	1.75 ± 0.10
Punch hole position	F	3.50 ± 0.10
Sprocket hole pitch	P_0	4.00 ± 0.10
Punch hole pitch	P_1	4.00 ± 0.10
Embossment center	P_2	2.00 ± 0.10
Overall tape thickness	T	0.20 ± 0.05
Tape width	W	8.00 ± 0.20
Reel width	W_1	MAX. 14.50

Note *: A_0 , B_0 , and K_0 are determined by component size. The clearance between the components and the cavity must be within 0.05 mm min. to 0.5 mm

ORDER INFORMATION

Part Number	Marking Code	Reel Size	Quantity
ABC846AWH	1A	7"	3,000
ABC846BWH	1B		
ABC846CWH	1C		



SUGGESTED SOLDER PAD LAYOUT

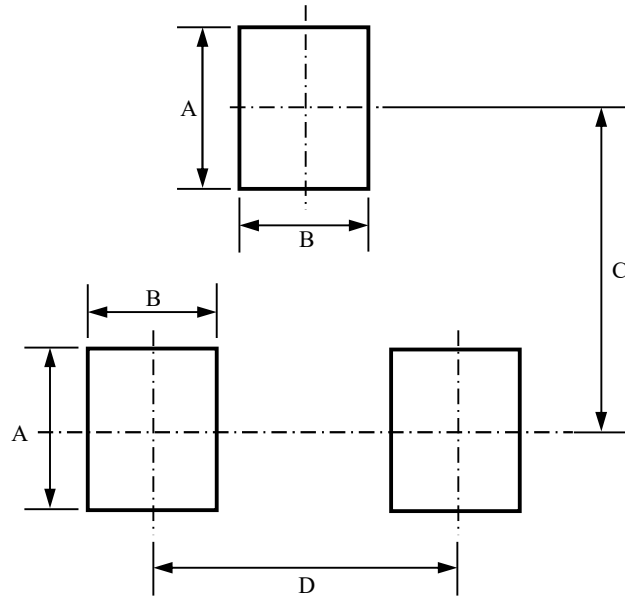

Unit :mm

PACKAGE	A	B	C	D
SOT-323	0.80	0.80	1.60	1.30