



2SC3324 GH / LH

NPN TRANSISTORS

FEATURES

· Suffix "H" indicates Halogen-free parts, ex.2SC3324GH

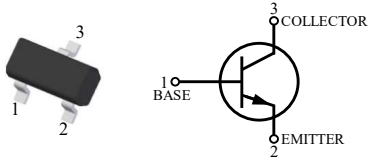

SOT-23

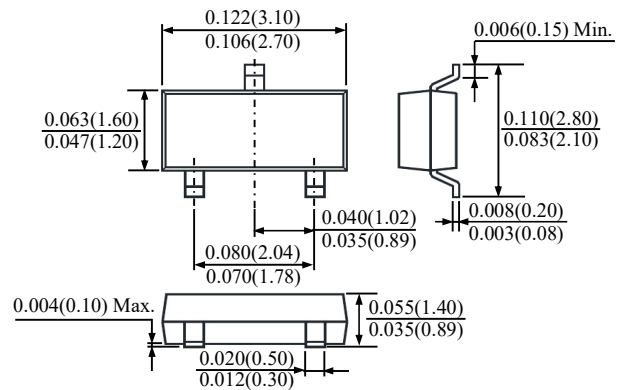

Dimensions in inch and (millimeter)

Maximum Ratings ($T_A = 25\text{ }^\circ\text{C}$ unless otherwise noted)

Parameter	Symbol	Value	Unit
Collector Base Voltage	V_{CB0}	120	V
Collector Emitter Voltage	V_{CEO}	120	V
Emitter Base Voltage	V_{EBO}	5	V
Collector Current	I_C	100	mA
Power Dissipation	P_D	200	mW
Thermal Resistance from Junction to Ambient (Note 1)	$R_{\theta JA}$	625	$^\circ\text{C}/\text{W}$
Operating Junction Temperature Range	T_J	- 55 to + 150	$^\circ\text{C}$
Storage Temperature Range	T_{stg}	- 55 to + 150	$^\circ\text{C}$

Note :

1. Device mounted on FR-4 substrate PC board, 2oz copper, with minimum recommended pad layout.

Electrical Characteristics ($T_A = 25\text{ }^\circ\text{C}$ unless otherwise specified)

Parameter	Conditions	Symbol	Min.	Typ.	Max.	Unit
DC Current Gain	$V_{CE}=6\text{V}, I_C=2\text{mA}$	G	200	-	400	-
		L	350	-	700	-
Collector Base Cutoff Current	$V_{CB}=120\text{V}$	I_{CB0}	-	-	100	nA
Emitter Base Cutoff Current	$V_{EB}=5\text{V}$	I_{EBO}	-	-	100	nA
Collector Base Breakdown Voltage	$I_C=100\mu\text{A}$	$V_{(BR)CB0}$	120	-	-	V
Collector Emitter Breakdown Voltage	$I_C=1\text{mA}$	$V_{(BR)CEO}$	120	-	-	V
Emitter Base Breakdown Voltage	$I_E=10\mu\text{A}$	$V_{(BR)EBO}$	5	-	-	V
Collector Emitter Saturation Voltage	$I_C=10\text{mA}, I_B=1\text{mA}$	$V_{CE(sat)}$	-	-	0.3	V
Transition Frequency	$V_{CE}=6\text{V}, I_C=1\text{mA}$	f_T	-	100	-	MHz
Collector Output Capacitance	$V_{CB}=10\text{V}, f=1\text{MHz}$	C_{ob}	-	2	-	pF



2SC3324 GH / LH

NPN TRANSISTORS

RATINGS AND CHARACTERISTIC CURVES

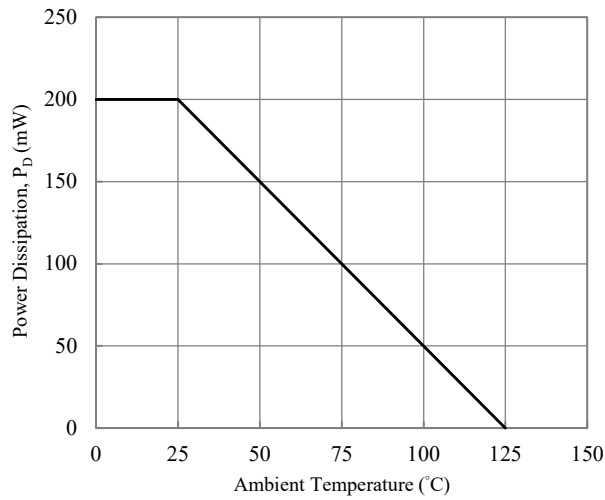

Fig. 1 Power Derating Curves

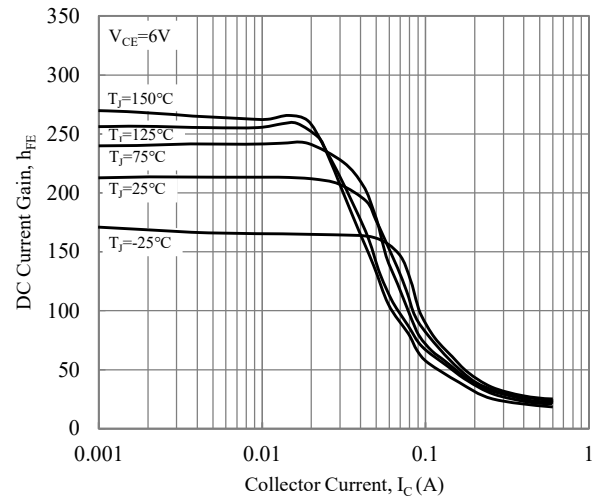

Fig. 2 Current Gain vs. Collector Current

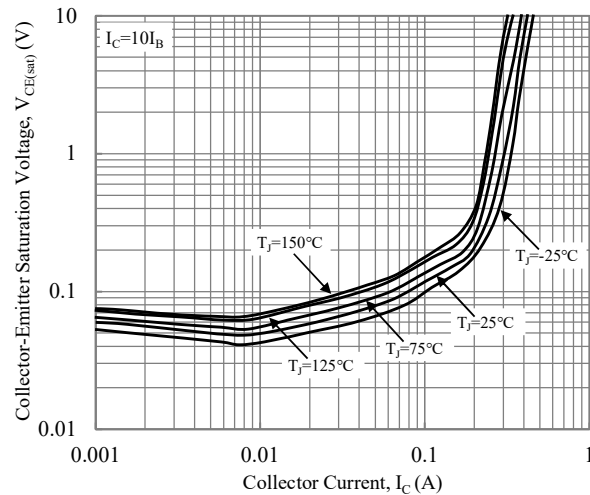

Fig. 3 Collector-Emmitter Saturation Voltage vs. Collector Current

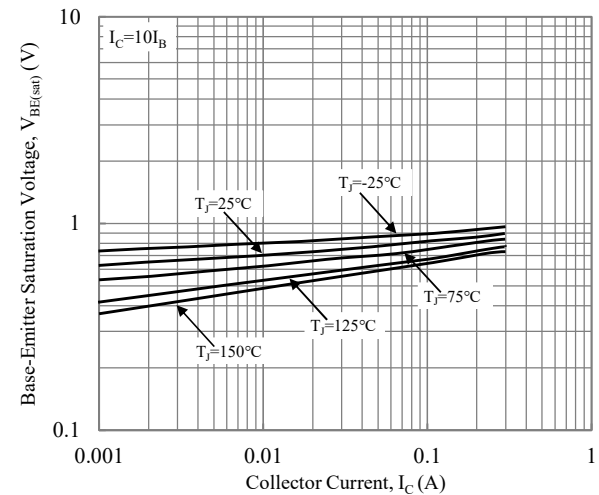

Fig. 4 Base-Emmitter Saturation Voltage vs. Collector Current

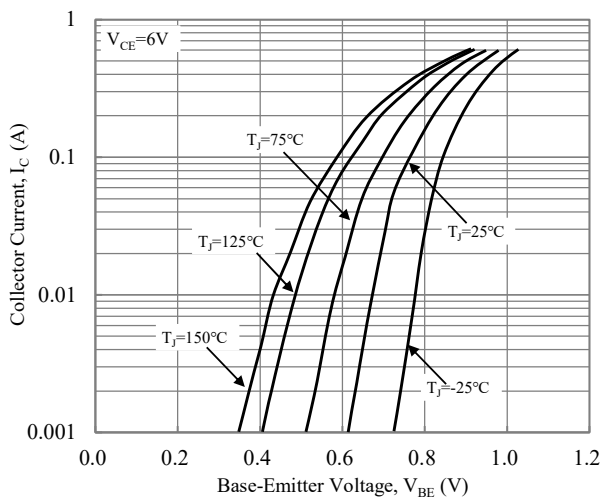

Fig. 5 Base-Emmitter Voltage vs. Collector Current

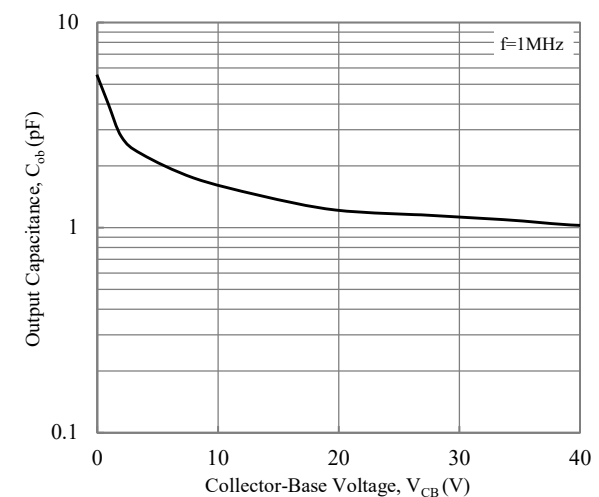

Fig. 6 Output Capacitance



2SC3324 GH / LH

NPN TRANSISTORS

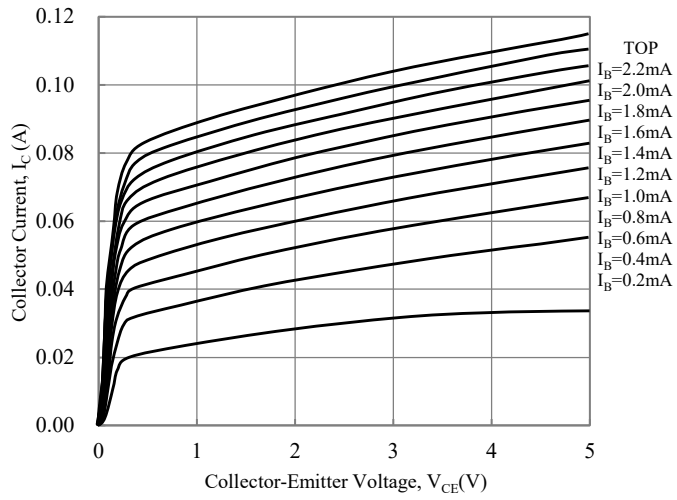

Fig. 7 Collector-Emitter Voltage vs. Collector Current



2SC3324 GH / LH

NPN TRANSISTORS

TAPE & REEL SPECIFICATION

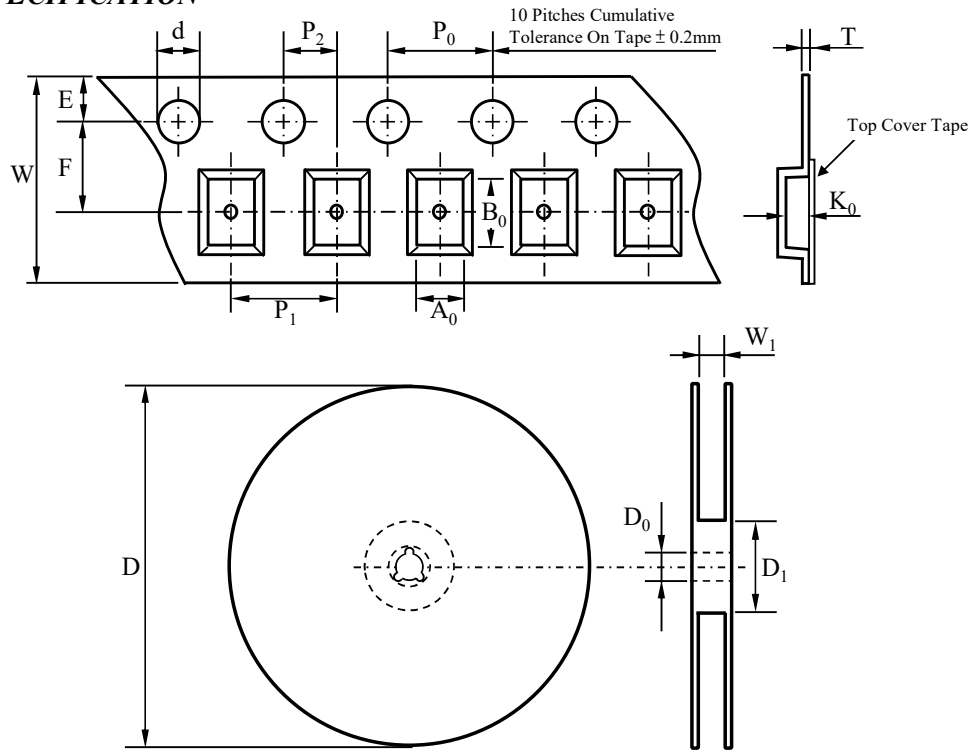

Item	Symbol	SOT-23
Carrier width	A_0	*
Carrier length	B_0	
Carrier depth	K_0	
Sprocket hole	d	1.50 ± 0.10
Reel outside diameter	D	178.00 ± 2.00
Feed hole width	D_0	13.00 ± 0.50
Reel inner diameter	D_1	MIN. 50.00
Sprocket hole position	E	1.75 ± 0.10
Punch hole position	F	3.50 ± 0.10
Sprocket hole pitch	P_0	4.00 ± 0.10
Punch hole pitch	P_1	4.00 ± 0.10
Embossment center	P_2	2.00 ± 0.10
Overall tape thickness	T	0.20 ± 0.05
Tape width	W	8.00 ± 0.20
Reel width	W_1	MAX. 14.50

ORDER INFORMATION

Part Number	Marking Code	Reel Size	Quantity
2SC3324GH	4A	7"	3,000
2SC3324LH	4B		



2SC3324 GH / LH

NPN TRANSISTORS

SUGGESTED SOLDER PAD LAYOUT

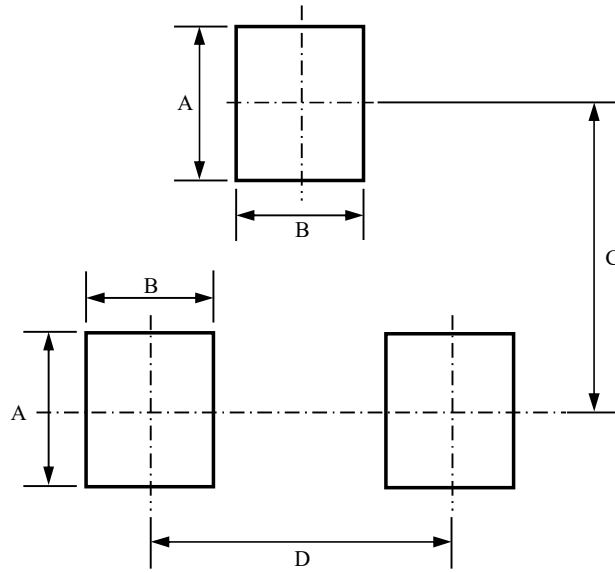

Unit :mm

PACKAGE	A	B	C	D
SOT-23	1.00	0.80	2.00	1.90