

MMBT3904

NPN TRANSISTOR

FEATURES

- As complementary types the PNP transistors MMBT3906 is recommended
- Suffix "H" indicates Halogen-free parts, ex. MMBT3904H

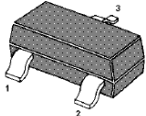

1, Base 2, Emitter 3, Collector

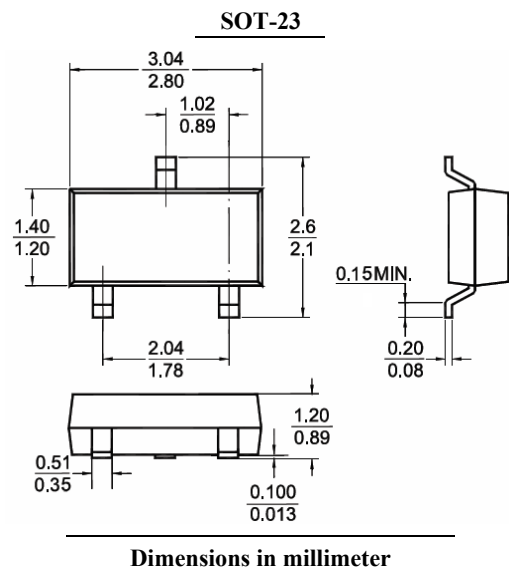

Maximum Ratings ($T_A = 25^\circ\text{C}$ unless otherwise noted)

Parameter	Symbol	Value	Unit
Collector-Base Voltage	V_{CBO}	60	V
Collector-Emitter Voltage	V_{CEO}	40	V
Emitter-Base Voltage	V_{EBO}	6.0	V
Collector Current	I_C	200	mA
Total Device Dissipation FR-5 Board ⁽¹⁾ Derate above 25°C	P_D	225 1.8	mW mW / °C
Thermal Resistance Junction to Ambient	$R_{\theta JA}$	556	°C / W
Total Device Dissipation Alumina Substrate ⁽²⁾	P_D	300 2.4	mW mW / °C
Thermal Resistance Junction to Ambient	$R_{\theta JA}$	417	°C / W
Junction and Storage Temperature Range	T_J, T_{stg}	-55 to +150	°C

(1) Device on FR-5 = 1.0 x 0.75 x 0.062 in.

(2) Device on alumina substrate = 0.4 x 0.3 x 0.024 in. 99.5% alumina.

Electrical Characteristics ($T_A = 25^\circ\text{C}$ unless otherwise specified)

Parameter	Conditions	Symbol	Min.	Max.	Unit
Collector-base breakdown voltage	$I_C = 10\mu\text{A}$	$V_{(BR)CBO}$	60	--	V
Collector-emitter breakdown voltage ⁽³⁾	$I_C = 1.0\text{mA}$	$V_{(BR)CEO}$	40	--	V
Emitter-base breakdown voltage	$I_E = 10\mu\text{A}$	$V_{(BR)EBO}$	6.0	--	V
Base cut-off current	$V_{CE} = 30\text{V}, V_{EB} = 3.0\text{V}$	I_{BL}	--	50	nA
Collector cut-off current	$V_{CE} = 30\text{V}, V_{EB} = 3.0\text{V}$	I_{CEX}	--	50	nA
DC current gain	$V_{CE} = 1.0\text{V}, I_C = 0.1\text{mA}$	h_{FE}	40	--	--
	$V_{CE} = 1.0\text{V}, I_C = 1.0\text{mA}$		70	--	
	$V_{CE} = 1.0\text{V}, I_C = 10\text{mA}$		100	300	
	$V_{CE} = 1.0\text{V}, I_C = 50\text{mA}$		60	--	
	$V_{CE} = 1.0\text{V}, I_C = 100\text{mA}$		30	--	
Collector-emitter saturation voltage ⁽³⁾	$I_C = 10\text{mA}, I_B = 1.0\text{mA}$	$V_{CE(sat)}$	--	0.2	V
	$I_C = 50\text{mA}, I_B = 5.0\text{mA}$		--	0.3	
Base-emitter saturation voltage ⁽³⁾	$I_C = 10\text{mA}, I_B = 1.0\text{mA}$	$V_{BE(sat)}$	0.65	0.85	V
	$I_C = 50\text{mA}, I_B = 5.0\text{mA}$		--	0.95	

(3) Pulse Test: Pulse Width <300 μs , Duty Cycle <2.0%.

MMBT3904

NPN TRANSISTOR

Electrical Characteristics ($T_A = 25\text{ }^\circ\text{C}$ unless otherwise specified)

Parameter	Conditions	Symbol	Min.	Max.	Unit
Current-gain — bandwidth product	$V_{CE} = 20\text{V}$, $I_C = 10\text{mA}$, $f = 100\text{MHz}$	f_T	300	--	MHz
Output capacitance	$V_{CB} = 5.0\text{V}$, $I_E = 0$, $f = 1.0\text{MHz}$	C_{obo}	--	4.0	pF
Input capacitance	$V_{BE} = 0.5\text{V}$, $I_C = 0$, $f = 1.0\text{MHz}$	C_{ibo}	--	8.0	pF
Input impedancen	$V_{CE} = 10\text{V}$, $I_C = 1.0\text{mA}$, $f = 1.0\text{kHz}$	h_{ie}	1.0	10	k Ω
Voltage feedback Ratio	$V_{CE} = 10\text{V}$, $I_C = 1.0\text{mA}$, $f = 1.0\text{kHz}$	h_{re}	0.5	8.0	$\times 10^{-4}$
Small-signal current gain	$V_{CE} = 10\text{V}$, $I_C = 1.0\text{mA}$, $f = 1.0\text{kHz}$	h_{fe}	100	400	--
Output admittance	$V_{CE} = 10\text{V}$, $I_C = 1.0\text{mA}$, $f = 1.0\text{kHz}$	h_{oe}	1.0	40	μmhos
Noise figure	$V_{CE} = 5.0\text{V}$, $I_C = 100\mu\text{A}$, $R_S = 1.0\text{k}\Omega$, $f = 1.0\text{kHz}$	NF	--	5.0	dB
Delay time	$V_{CC} = 3.0\text{V}$, $V_{BE} = -0.5\text{V}$	t_d	--	35	nS
Rise time	$I_C = 10\text{mA}$, $I_{B1} = 1.0\text{mA}$	t_r	--	35	nS
Storage time	$V_{CC} = 3.0\text{V}$, $I_C = 10\text{mA}$	t_s	--	200	nS
Fall time	$I_{B1} = I_{B2} = 1.0\text{mA}$	t_f	--	50	nS

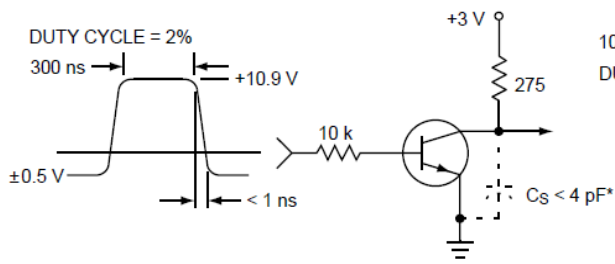

Figure 1. Delay and Rise Time Equivalent Test Circuit

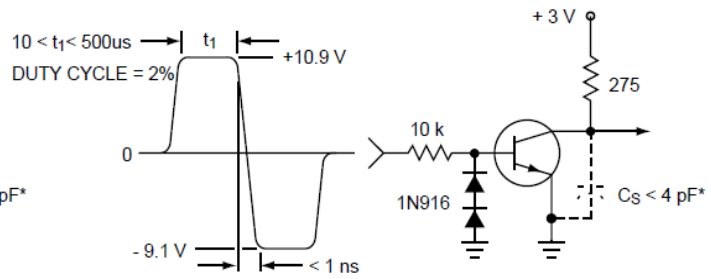

Figure 2. Storage and Fall Time Equivalent Test Circuit

* Total shunt capacitance of test jig and connectors

RATINGS AND CHARACTERISTIC CURVES

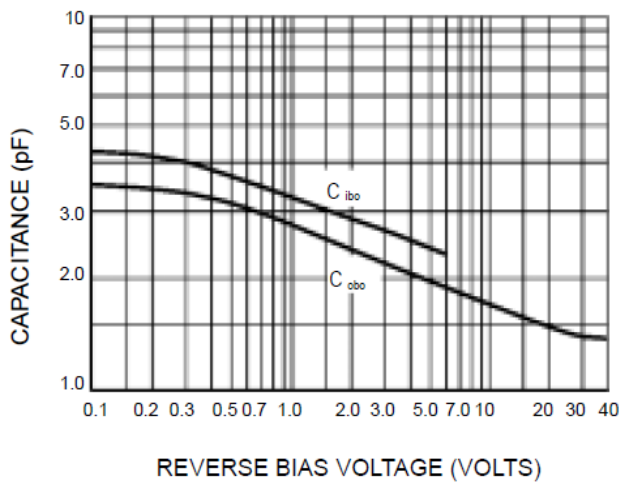

Figure 3. Capacitance

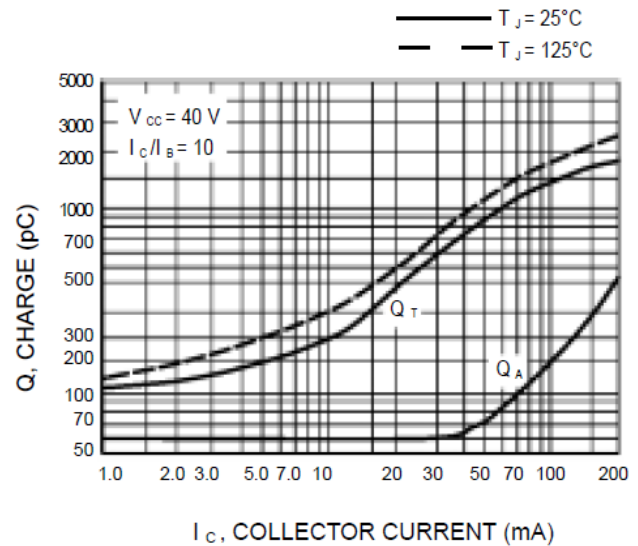

Figure 4. Charge Data

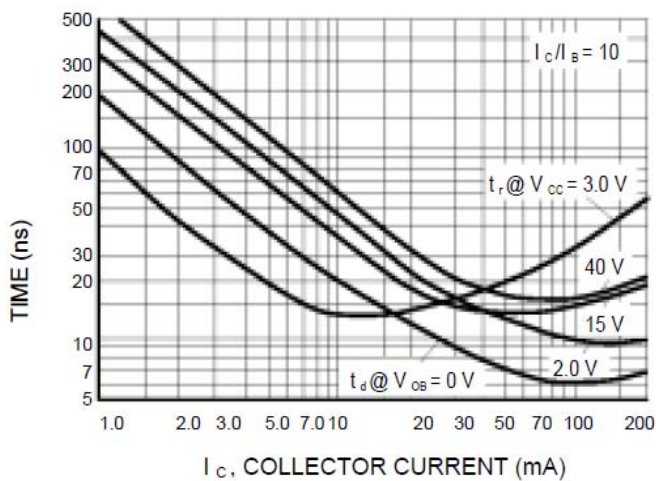

Figure 5. Turn-On Time

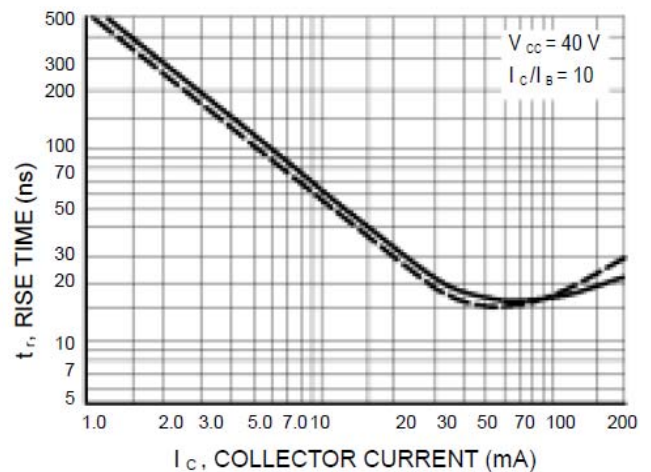

Figure 6. Rise Time

RATINGS AND CHARACTERISTIC CURVES

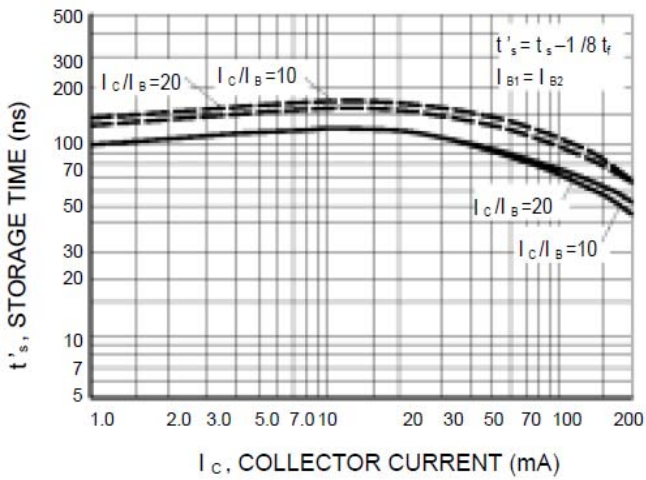

Figure 7. Storage Time

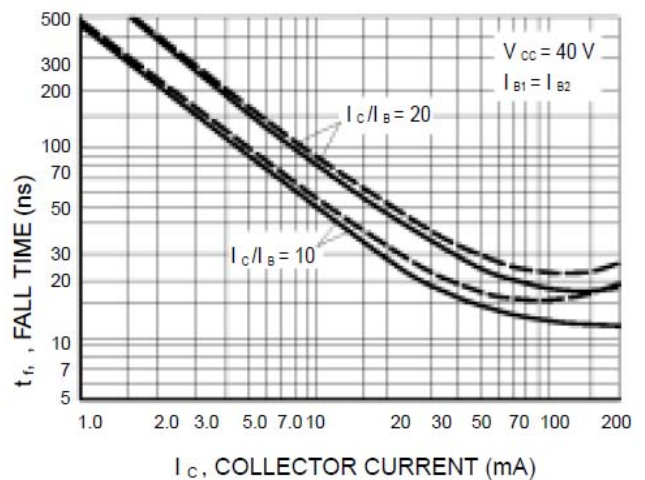

Figure 8. Fall Time

TYPICAL AUDIO SMALL-SIGNAL CHARACTERISTICS

NOISE FIGURE VARIATIONS

($V_{CE} = 5.0\text{ V}$, $T_A = 25^\circ\text{C}$, Bandwidth = 1.0 Hz)

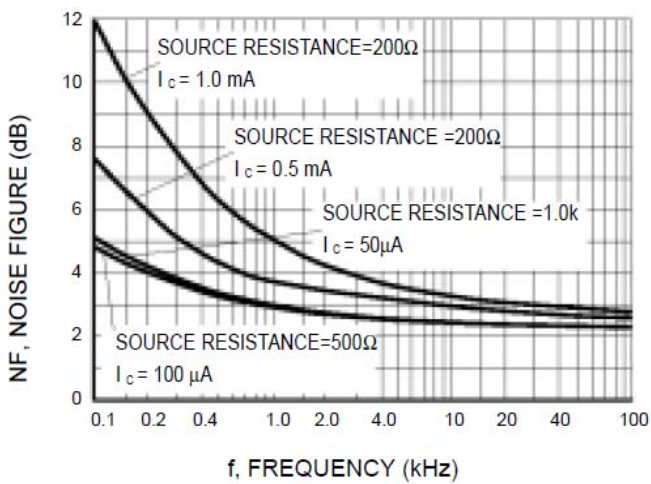

Figure 9.

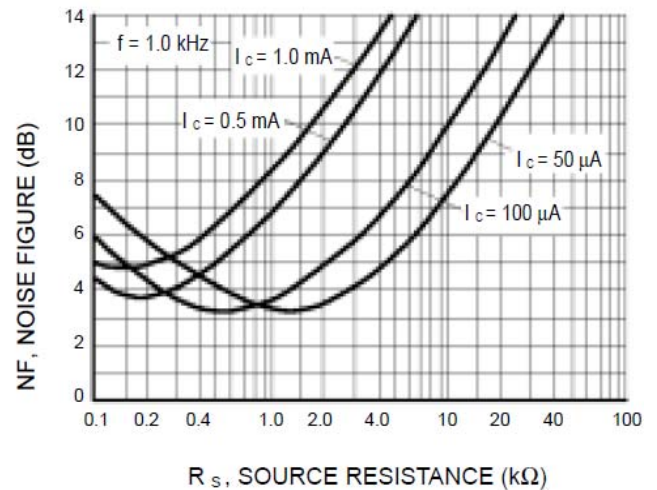

Figure 10.

h PARAMETERS

($V_{CE} = 10\text{ V}$, $f = 1.0\text{ kHz}$, $T_A = 25^\circ\text{C}$)

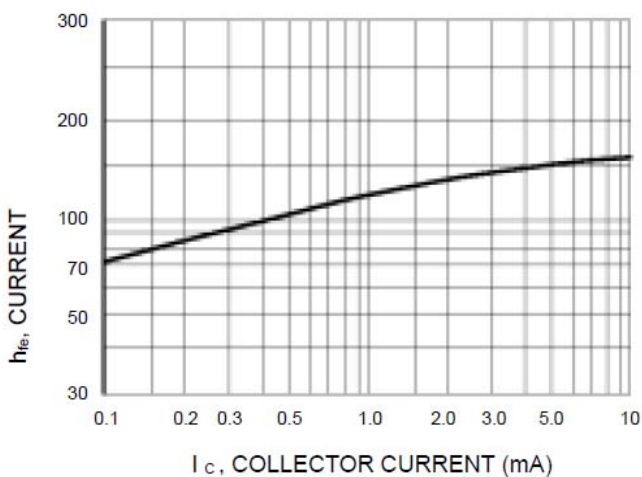

Figure 11. Current Gain

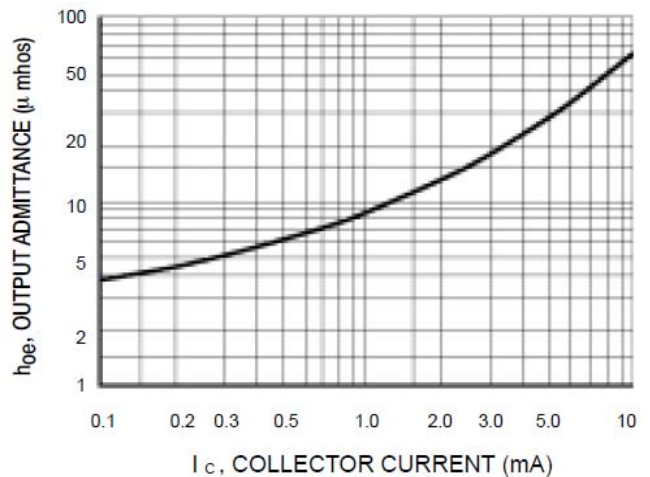
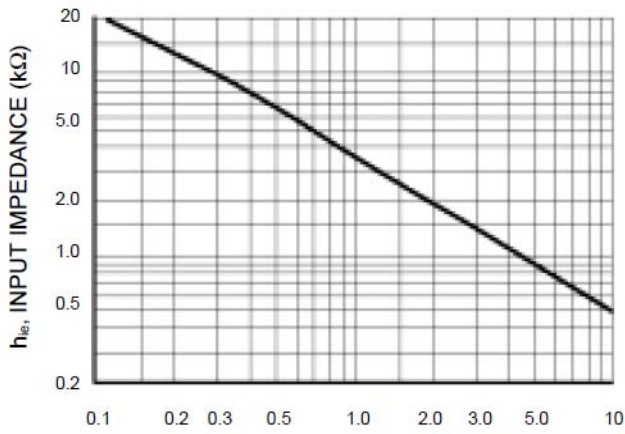
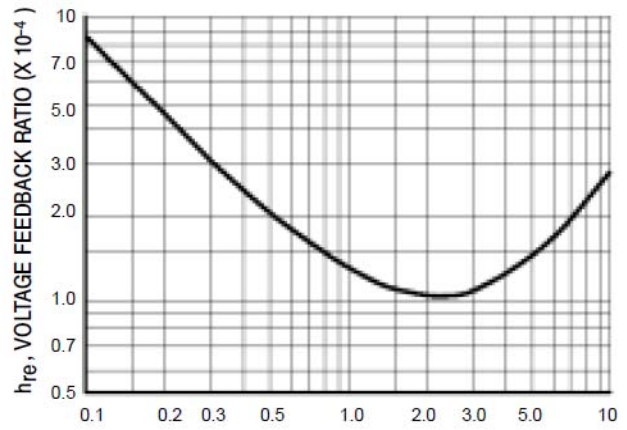

Figure 12. Output Admittance

RATINGS AND CHARACTERISTIC CURVES



I_c , COLLECTOR CURRENT (mA)
Figure 13. Input Impedance



I_c , COLLECTOR CURRENT (mA)
Figure 14. Voltage Feedback Ratio

TYPICAL STATIC CHARACTERISTICS

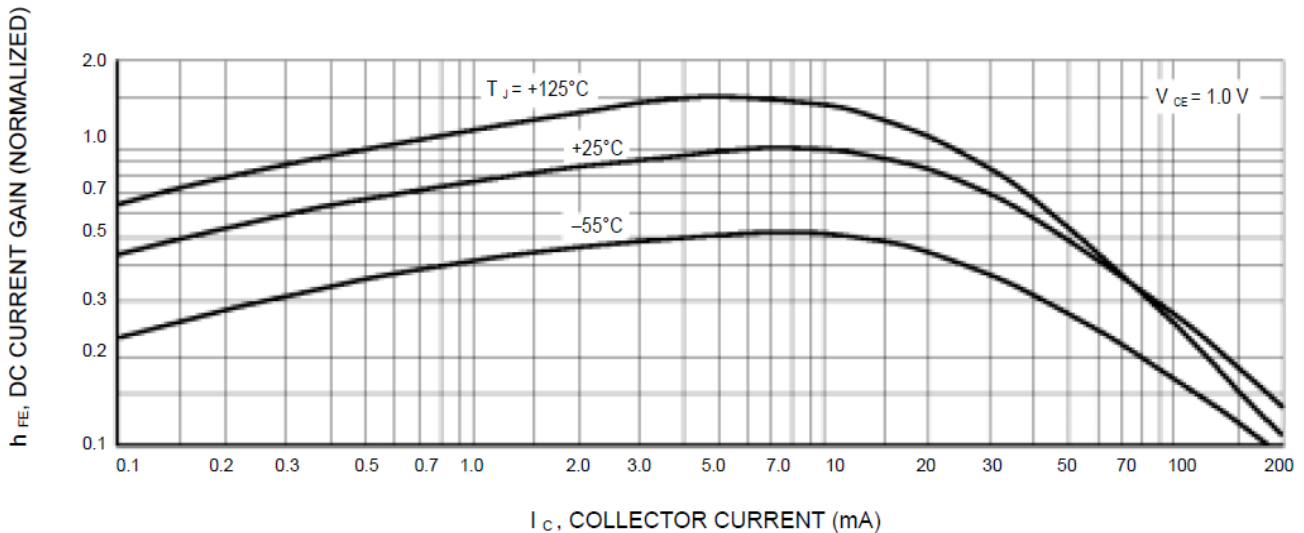

I_c , COLLECTOR CURRENT (mA)
Figure 15. DC Current Gain

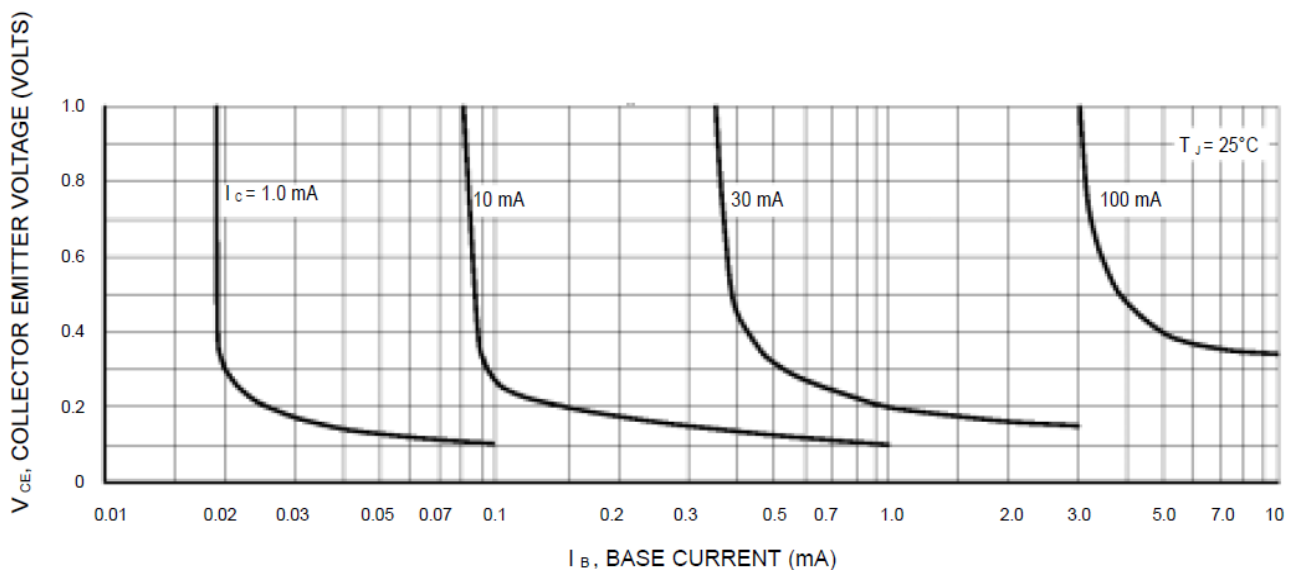

I_B , BASE CURRENT (mA)
Figure 16. Collector Saturation Region

RATINGS AND CHARACTERISTIC CURVES

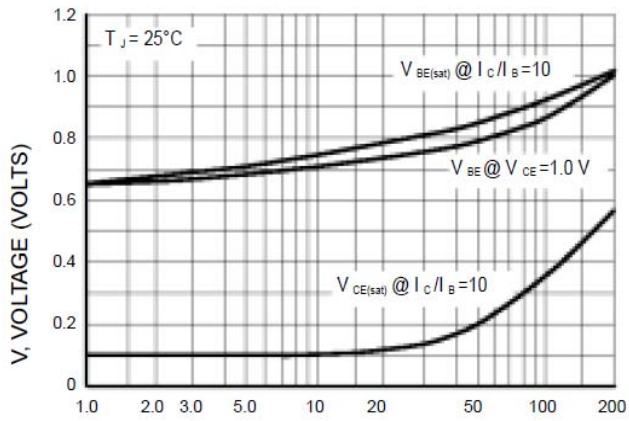

I_C , COLLECTOR CURRENT (mA)
Figure 17. "ON" Voltages

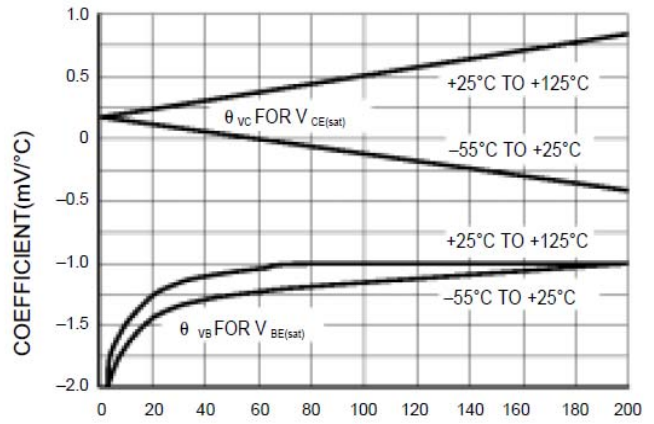

I_C , COLLECTOR CURRENT (mA)
Figure 18. Temperature Coefficients