

MMBT2222A

NPN TRANSISTOR

FEATURES

· Suffix "H" indicates Halogen-free parts, ex. MMBT2222AH

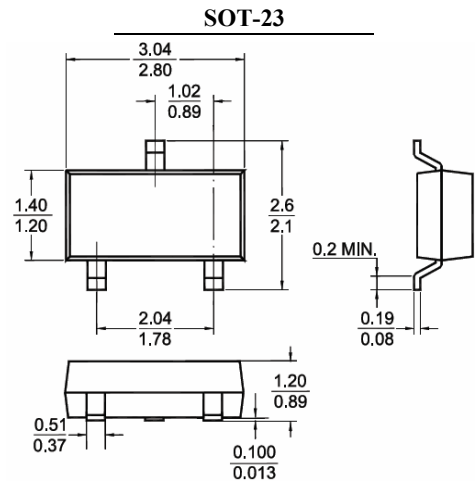
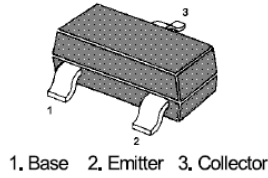

Dimensions in millimeter

Maximum Ratings ($T_A = 25\text{ }^\circ\text{C}$ unless otherwise noted)

Parameter	Symbol	Value	Unit
Collector Base Voltage	V_{CBO}	75	V
Collector Emitter Voltage	V_{CEO}	40	V
Emitter Base Voltage	V_{EBO}	6.0	V
Collector Current	I_C	600	mA
Power Dissipation	P_{tot}	225	mW
Junction Temperature	T_j	150	$^\circ\text{C}$
Storage Temperature Range	T_{stg}	- 55 to + 150	$^\circ\text{C}$

Electrical Characteristics ($T_A = 25\text{ }^\circ\text{C}$ unless otherwise specified)

Parameter	Conditions	Symbol	Min.	Max.	Unit
DC Current Gain	$I_C = 0.1\text{ mA}, V_{CE} = 10\text{ V}$	h_{FE}	35	-	-
	$I_C = 1\text{ mA}, V_{CE} = 10\text{ V}$		50	-	
	$I_C = 10\text{ mA}, V_{CE} = 10\text{ V}$		75	-	
	$I_C = 150\text{ mA}, V_{CE} = 1\text{ V}$		50	-	
	$I_C = 150\text{ mA}, V_{CE} = 10\text{ V}$		100	300	
	$I_C = 500\text{ mA}, V_{CE} = 10\text{ V}$		40	-	
Collector Base Cutoff Current	$V_{CB} = 60\text{ V}$	I_{CBO}	-	10	nA
Emitter Base Cutoff Current	$V_{EB} = 3\text{ V}$	I_{EBO}	-	100	nA
Collector Base Breakdown Voltage	$I_C = 10\text{ }\mu\text{A}$	$V_{(BR)CBO}$	75	-	V
Collector Emitter Breakdown Voltage	$I_C = 10\text{ mA}$	$V_{(BR)CEO}$	40	-	V
Emitter Base Breakdown Voltage	$I_E = 10\text{ }\mu\text{A}$	$V_{(BR)EBO}$	6.0	-	V

MMBT2222A

NPN TRANSISTOR

Electrical Characteristics ($T_A = 25\text{ }^\circ\text{C}$ unless otherwise specified)

Parameter	Conditions	Symbol	Min.	Max.	Unit
Collector Emitter Saturation Voltage	$I_C = 150\text{ mA}, I_B = 15\text{ mA}$	$V_{CE(sat)}$	-	0.3	V
	$I_C = 500\text{ mA}, I_B = 50\text{ mA}$		-	1.0	
Base Emitter Saturation Voltage	$I_C = 150\text{ mA}, I_B = 15\text{ mA}$	$V_{BE(sat)}$	0.6	1.2	V
	$I_C = 500\text{ mA}, I_B = 50\text{ mA}$		-	2.0	
Transition Frequency	$-I_E = 20\text{ mA}, V_{CE} = 20\text{ V},$ $f = 100\text{ MHz}$	f_T	300	-	MHz
Collector Output Capacitance	$V_{CB} = 10\text{ V}, f = 100\text{ KHz}$	C_{ob}	-	8.0	pF
Delay Time	$V_{CC} = 30\text{ V}, V_{BE(OFF)} = 0.5\text{ V},$ $I_C = 150\text{ mA}, I_{B1} = 15\text{ mA}$	t_d	-	10	nS
Rise Time	$V_{CC} = 30\text{ V}, V_{BE(OFF)} = 0.5\text{ V},$ $I_C = 150\text{ mA}, I_{B1} = 15\text{ mA}$	t_r	-	25	nS
Storage Time	$V_{CC} = 30\text{ V}, I_C = 150\text{ mA},$ $I_{B1} = -I_{B2} = 15\text{ mA}$	t_s	-	225	nS
Fall Time	$V_{CC} = 30\text{ V}, I_C = 150\text{ mA},$ $I_{B1} = -I_{B2} = 15\text{ mA}$	t_f	-	60	nS

RATINGS AND CHARACTERISTIC CURVES

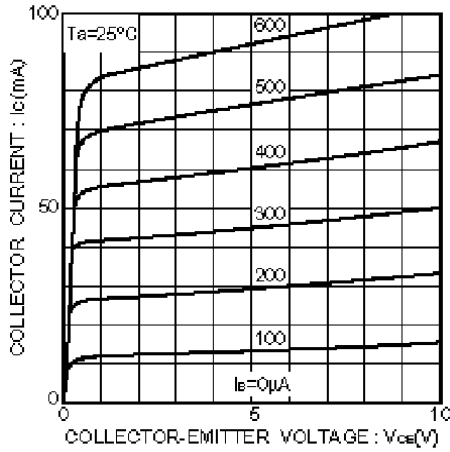

Fig.1 Grounded emitter output characteristics

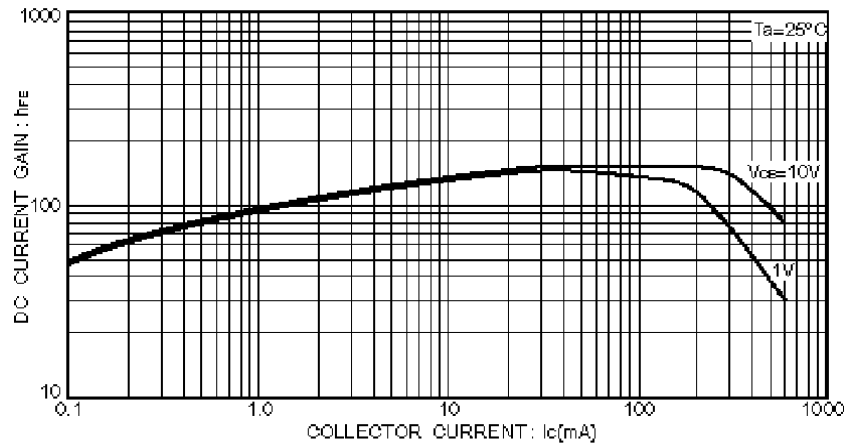

Fig.3 DC current gain vs. collector current(I)

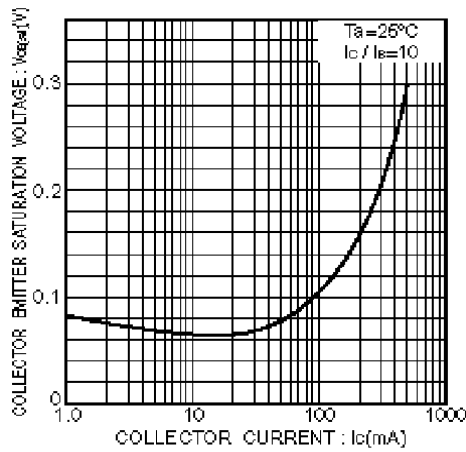

Fig.2 Collector-emitter saturation voltage vs. collector current

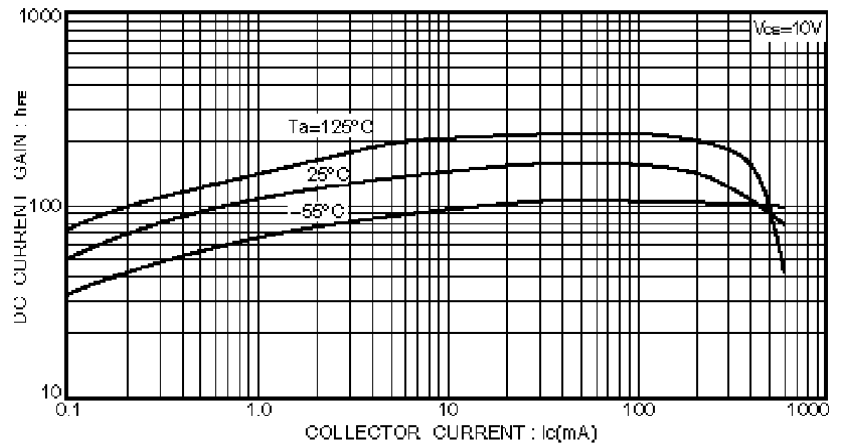

Fig.4 DC current gain vs. collector current(II)

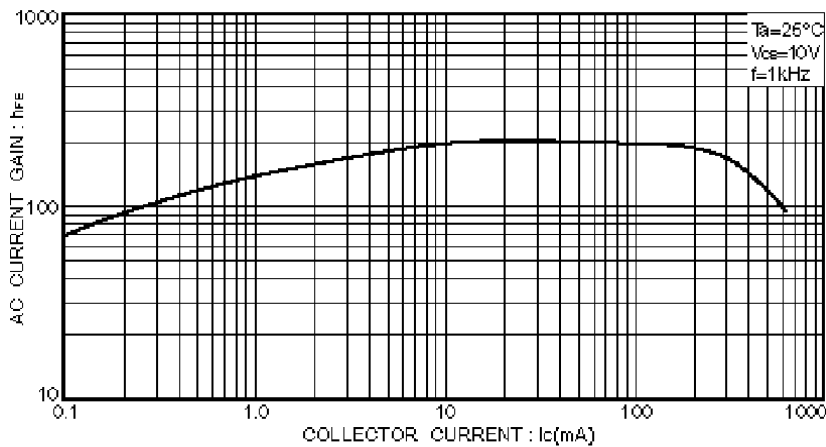

Fig.5 AC current gain vs. collector current

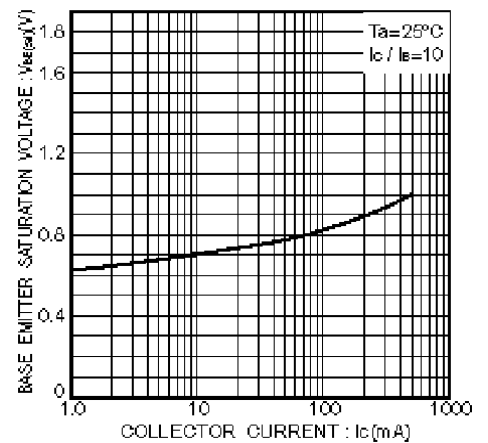

Fig.6 Base-emitter saturation voltage vs. collector current